

# **Mantis** **Media Gateway**<sup>TM</sup>

User Manual

### ***Trademarks***

Focus Enhancements, Visual Circuits, and Mantis logos are registered trademarks in the United States and other countries. All other products, services or company names mentioned herein are claimed as trademarks and trade names by their respective companies.

© Focus Enhancements  
1999-2005

All rights reserved. No portion of this manual may be copied by any means without the prior consent of Focus Enhancements.

Focus Enhancements, Midwest Headquarters  
5155 East River Road, Suite 401  
Minneapolis, MN 55421 USA  
<http://www.visualcircuits.com>

Publication Number: 813-0053b

All specifications, notices and warnings are subject to change without notice.

# Mantis MG™ Safety Requirements

## IMPORTANT SAFETY INSTRUCTIONS:

### The following safety instructions apply to the Mantis Media Gateway (MG):

1. Read and follow all warning notices and instructions marked on the product or included in this manual. Opening or removing covers and/or components may expose you to dangerous high voltage points or other risks. Only qualified personnel should perform all servicing.
2. The maximum ambient temperature for the Mantis is 114 degrees Fahrenheit (45 degrees Celsius). Care should be given to allow sufficient air circulation or space between units when the Mantis is installed in a closed or multi-unit rack assembly because the operating ambient temperature of the rack environment must be greater than room ambient temperature.
3. Slots and openings in the cabinet (chassis) are provided for ventilation. To ensure reliable operation of the product and to protect it from overheating, maintain a minimum of 1-inch (2.5-cm) clearance on the top and sides.
4. Installation of the Mantis in a rack without sufficient airflow can be unsafe.
5. If installed in a rack, the rack should safely support the combined weight of all equipment it supports. A fully loaded Mantis weighs 15 pounds (6.8 kg).
6. The connections and equipment of the Mantis should be capable of operating safely with the maximum power requirements of the Mantis. In the event of a power overload, the supply circuits and supply wiring should not become hazardous.
7. Models with AC power inputs are intended to be used with the three-wire grounding type plug (a plug that has a grounding pin). This is a safety feature. Equipment grounding is vital to ensure safe operation. Do not defeat the purpose of grounding type plugs by modifying the plug or using an adapter.
8. If a three-wire grounding type power source is not available, consult a qualified electrician to determine another method of grounding the equipment.
9. Install only in restricted areas in accordance with Articles 110-16, 100-17 and 110-18 of the National Electrical Code, ANSI/NFPA 70.

10. Do not allow anything to rest on the power cord and do not locate the product where persons will walk on or come in contact with the power cord.

## **POWER AND GROUND REQUIREMENTS:**

Determine that the cumulative power requirements of the Mantis plus other equipment in the rack do not overload the supply circuits and/or wiring.

### **CAUTION**

**If using a power strip or similar supply, make sure the power requirements of the chassis, plus the cumulative power draw of any other equipment in the rack, do not overload the supply circuit.**

### **WARNING**

**For safe operation, this equipment must be properly grounded.**

The chassis should be reliably earth grounded to the rack equipment. This earth ground connection must be maintained when supply connection is other than direct connection to the branch circuit.

# RACK MOUNTING AND VENTILATION REQUIREMENTS:

If you are rack-mounting the Mantis base unit:

1. Always stack the rack from the bottom up to ensure a stable and safe rack.
2. The installation of the Mantis and other units within the rack should not reduce the airflow within the rack. The maximum recommended ambient temperature for the Mantis is 100.4 degrees Fahrenheit (38 degrees Celsius).
3. Determine that the cumulative power requirements of the Mantis plus the other equipment in the rack do not overload the rack supply circuit and/or wiring.
4. When installing, consider the location or locations of the Mantis players in relation to other devices located in an adjacent rack. Ensure that the Mantis air intake is not drawing directly upon heated air from another unit. **Rack Depth:** The minimum rack depth required to install the Mantis is 16 inches (41 cm). If cables are used, the rack should be EMI/RFI shielded. Ensure that the cables used meet EMI/RFI requirements and are shielded if exposed. **Side Rails:** The Mantis has side rails provided for mounting. If different rail mounts or sliding rails are used, consult the original manufacturer of this equipment to confirm they meet the weight and stress requirements in order to support the Mantis chassis.

# User Manual Regulatory Documentation

## CAUTION

**The CD-ROM/DVD-ROM drive contains a laser system and is a 'Class 1 Laser Product' under a U.S. Department of Health and Human Services (DHHS) Radiation Performance standard, according to the Radiation Control for Health and Safety Act of 1968.** Should a unit ever require maintenance, contact an authorized repair location.

## CAUTION

**There is danger of explosion if the battery is incorrectly replaced.**

A lithium battery on the product provides backup power for the device's timekeeping capability. The battery has an estimated life expectancy of ten years. When the battery starts to weaken, the date and time may become incorrect. If the battery fails, the unit must be sent back to Focus Enhancements - Midwest for battery replacement.

## WARNING

**An improperly grounded power supply can result in electrical shock.**

The AC power cord provided with your system has a grounded plug. Always use a grounded power cord with a properly grounded wall outlet.

## **Class A Statement FCC Part 15 (EN61000-3-2)**

This equipment has been tested and found to comply with the limits for a Class A digital device, pursuant to Part 15 (EN61000-3-2) of the FCC Rules. These limits are designed to provide reasonable protection against harmful interference when the equipment is operated in a commercial environment. This equipment generates, uses, and can radiate radio frequency energy and, if not installed and used in accordance with this instruction manual, may cause harmful interference to radio communications. Operation of this equipment in a residential area is likely to cause harmful interference in which case the user will be required to correct the interference at his or her own expense.



The Mantis complies with Part 15 (EN61000-3-2) of the FCC rules.

Operation is subject to the following two conditions:

1. This device may not cause harmful interference.
2. This device must accept any interference that may cause undesired operation.

 <b>WARNING</b>
<b>Changes or modifications to this unit not expressly approved by the party responsible for compliance could void the user's authority to operate the equipment.</b>

## **Industry Canada**

This Class A digital apparatus meets all requirements of the Canadian Interference-Causing Equipment Regulations.

Cet appareil numérique de la classe A respecte toutes les exigences du Règlement sur le matériel brouilleur du Canada.

## EMC and Safety Directive Compliance

The CE mark is affixed to this Visual Circuits product to confirm compliance with the following European Community Directives:

Council Directive 89/336/EEC of 3 May 1989 on the approximation of the laws of Member States relating to electromagnetic compatibility.

And

Council Directive 73/23/EEC of 19 February 1973 on the harmonization of the laws of Member States relating to electrical equipment designed for use within certain voltage limits:

Each amended by Council Directive 93/68/EEC of 22 July 1993 on the harmonization of CE marking requirements.

### **Class A Warning (EN55024, EN55022)**

In a domestic environment this product may cause radio interference in which case the user may be required to take adequate measures.

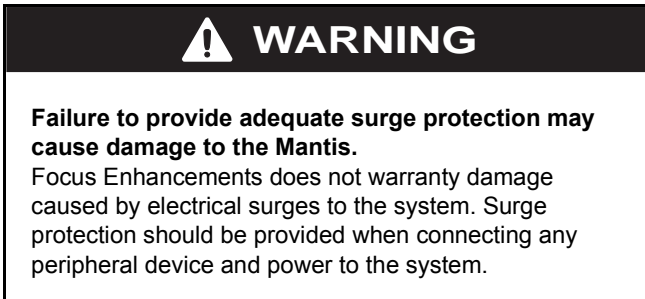

All specifications are subject to change without notice.



# CONTENTS

---

<b>Mantis Media Gateway™ Quick Start</b> .....	<b>1</b>
Introduction .....	1
Media Messenger and Webview .....	1
Mantis MG System .....	2
Plug and Play .....	3
Mantis MG Connections Guide .....	4
Video/VGA Cable .....	5
Audio Connections .....	6
Configuring for a Network .....	7
Attaching a Laptop or PC .....	7
Changing TCP/IP Settings .....	8
Front Panel .....	10
Display .....	10
Menu Control Buttons .....	10
<b>Encoding Requirements and Recommendations</b> .....	<b>15</b>
Standard Definition (SD) Encoding Requirements .....	15
SD Encoding Recommendations .....	16
High Definition (HD) Encoding Requirements .....	19
HD Encoding Recommendations .....	20
Encoding Software .....	20
<b>Smart Card</b> .....	<b>23</b>
Overview .....	23
Optional Features .....	23
Using the Smart Card .....	24
Inserting the Smart Card .....	24
Saving a Configuration to the Smart Card .....	25
Loading a Configuration from the Smart Card .....	26
Eject the Smart Card .....	27
If Smart Card Does Not Eject .....	27
Storing the Smart Card .....	27

<b>WEBVIEW™</b> .....	<b>29</b>
Overview .....	29
Accessing WebView .....	31
Step 1: Connect to the Network .....	31
Step 2: Determine the IP Address of the Mantis .....	32
Step 3: Establish Communications with the Mantis .....	34
Step 4: Enter User Name and Password .....	34
Using WebView .....	35
Transferring Media .....	36
Webview Software Update .....	38
Media Review .....	39
Using the Playlist Editor .....	42
Using the Schedule Editor .....	50
Using the Player Control Panel .....	61
Diagnostics .....	62
System Settings .....	71
HTTP Auto-Update Settings .....	89
USB Devices .....	90
Multicast Settings .....	94
Smart Card Settings .....	96
Advanced Settings .....	97
<b>Networking</b> .....	<b>99</b>
Overview .....	99
Getting Started .....	100
Media Messenger™ Software .....	101
Product Features .....	101
Benefits .....	101
<b>Updating Video Playback</b> .....	<b>103</b>
Overview of the Update Process .....	104
Content Log .....	108
Automatic Updating .....	109
Media Update Disc Updating .....	109
Drop & Go Disc Updating .....	111

---

FTP UPDATING .....	113
MULTICAST UPDATING .....	117
Manual Updating .....	121
WebView Updating .....	121
Standard CD/DVD Updating .....	121
Direct File Access Updating .....	122
<b>Log File Reporting .....</b>	<b>125</b>
Overview .....	125
Run Logs .....	126
Diagnostic Logs .....	127
Log Formats .....	128
Log Default Playlist .....	128
Maximum Log File Size .....	129
Uploading Log Files .....	129
<b>External Control Commands 131</b>	
Overview .....	131
Connecting via RS232 .....	131
Connecting via TCP/IP .....	132
Hyper Terminal Basics .....	133
VCC Control Commands .....	134
Playlist Playback Commands .....	134
Playlistload .....	134
Playlistplay .....	135
mpgLoad .....	136
mpgLoadNext .....	137
mpgLoadDef .....	138
mpgLoadNextDef .....	139
mpgClearDef .....	140
mpgPlay .....	141
mpgStop .....	142
mpgPlayAll .....	143
mpgStopAll .....	144
mpgBlack .....	145

---

mpgUnblack .....	146
Using Serial Commands To Create Playlists .....	147
Firefly System Commands .....	149
FireflyFtpUpdate .....	149
FireflyRestart .....	149
Callback Commands .....	150
mpgCallback .....	150
Audio and Video .....	151
mpgSetVolumeLeftRight .....	151
mpgMute .....	152
mpgUnMute .....	153
On-Screen Display Commands .....	154
osdLoadBMP .....	154
osdShow .....	156
osdHide .....	157
osdSetXYMix .....	158
Media Calls .....	159
mpgDir .....	159
mpgDelete .....	159
Information Calls .....	160
infoGetFile .....	160
infoGetPlaylist .....	161
infoGetSchedule .....	162
infoGetState .....	163
Networking Commands .....	164
FireflySetDefault .....	164
FireflySetIpAddr .....	165
FireflySetGateway .....	166
FireflySetNetmask .....	167
FireflySetNetworkType .....	168
FireflySetWeb_Enable .....	169
FireflyGetIpAddr .....	169
FireflyGetGateway .....	170
FireflyGetNetmask .....	170
FireflyGetNetworkType .....	171

---

FireflyGetWeb_Enable .....	171
LDV Control Commands .....	172
Introduction .....	172
COM Port Settings .....	172
Command Language Basics .....	174
Error Codes .....	174
Command Syntax .....	175
Address Arguments .....	175
Command Summary .....	176
Playback Commands .....	177
Play (PL) .....	177
Load Playlist/Schedule (LD) .....	179
Reject “Stop” (RJ) .....	180
Pause (PA) .....	181
Still (ST) .....	182
Search (SE) .....	183
Multi-Track Jump Forward (JF) .....	184
Multi-Track Jump Reverse (JR) .....	185
Display Control (DS) .....	186
Frame Number Request (?F) .....	187
Time Code Request (?T) .....	188
Chapter Number Request (?C) .....	189
Player Active Mode Request (?P) .....	190
Mantis Model Request (?X) .....	191
External Control Commands Quick Reference Guide:	192
<b>Troubleshooting .....</b>	<b>193</b>
General Issues .....	193
Restoration Mode .....	193
No Power to the Mantis (No LCD light or fan noise) ..	194
No Video Playback .....	195
No Video Playback on Digital RF (ATSC) Channel ..	196
Test File Does Not Play Properly On All Channels ...	196
Test File Does Not Display On One Channel .....	196
Stuttering Files During Playback .....	197

---

- Latent Images or Flashing During Playback . . . . . 199
- Some files in the playlist do not play . . . . . 200
- SMPTE time codes are not recognized properly . . . . . 200
- File Related Problems . . . . . 201
  - File Copy Error Handling . . . . . 201
  - Serial Command Fails, Returning NAK . . . . . 202
  - Update Fails . . . . . 202
  - Smart Card does not eject . . . . . 202
- Preventing Cabling and Connection Problems . . . . . 203
- Front Panel Display Error Messages . . . . . 204
  - Bad FPL/FSC . . . . . 204
  - Bad FTP Dir . . . . . 204
  - Bad IP Address . . . . . 204
  - Bad User/Pass . . . . . 204
  - Cant List Media . . . . . 204
  - Cant List Scripts . . . . . 204
  - Download Fail . . . . . 205
  - FTP Failed Networking Off . . . . . 205
  - Invalid FTP IP . . . . . 205
  - Missing MPEG/Overlay . . . . . 205
  - No Directory . . . . . 205
  - No IP Address . . . . . 205
  - No Local FPL/FSC . . . . . 206
  - No Valid TAR/FPL . . . . . 206
  - Proxy Settings . . . . . 206
  - Transfer Error . . . . . 206
- Returning Materials to Focus Enhancements  
(VAR/Distributor) . . . . . 207

**Technical Specifications . . . . . 209**

# MANTIS MEDIA GATEWAY™

## QUICK START

---

## Introduction

Thank you for purchasing the Mantis Media Gateway (MG).

Mantis media players are flexible and scalable digital media delivery systems that are designed for enterprise-wide applications. Bundled with Media Messenger™ and WebView™ software, Mantis media players deliver scheduled, live, or interactive playback in almost any media format while supporting independent output whether in high or standard definition or a combination of both.

## Media Messenger and Webview

The Mantis MG includes Media Messenger and WebView, powerful applications for creating, scheduling, distributing, managing, and auditing digital content throughout the enterprise.

## Mantis MG System



The basic Mantis MG system includes:

### Features

- ❑ Two independent channels with a variety of media output types,
- ❑ 32-bit accelerated graphics output, supporting Multi-Zone™ functionality,
- ❑ Mantis has open slots allowing for future expansion,
- ❑ CD/DVD drive,
- ❑ 160 GB Hard drive for media and system log storage,
- ❑ Smart Card for configuration and security

### Networking and Control

- ❑ 10/100 Mbps Ethernet
- ❑ SNMP, Satellite and terrestrial multicast support
- ❑ Content updating via FTP or HTTP (manual or automatic)
- ❑ TCP/IP or serial control with Visual Circuits protocol
- ❑ Media Messenger™ software for scheduling and content distribution
- ❑ WebView™ browser-based user interface with WebView User Manual (pdf) stored on Mantis

### Audio

- ❑ Stereo or Dolby Digital™ via S/PDIF
- ❑ Stereo analog MPEG Layers 1, 2, 3

### Video

- ❑ MPEG 1 and 2,
- ❑ NTSC/PAL transcoding



## Plug and Play

The Mantis comes loaded with sample videos that are useful as you become familiar with the Mantis features and for diagnostic purposes. Video playback is typically controlled through a “playlist” that defines which videos are played, on which channels, and in what order. Only one playlist can be active at any time, though any number of playlists can be stored on the Mantis for later use. Whenever the Mantis is turned on, the playlist that was last in use reloads and playback begins automatically.

To quickly test the Mantis, plug it in, connect the cables, and turn it on.

1. Connect the power cable to the back of the Mantis and plug it in to a power source.
2. Connect video and audio cables to the backplane following the appropriate Mantis connections guide on the following page.
3. Connect the video and audio cables from the Mantis to the video and audio inputs on the video monitor(s) and audio components.
4. Connect the Mantis to a network, see *Configuring for a Network* on page 7.
5. At startup, the Mantis runs through a short series of self-diagnostics before beginning automated playback.



### **Mantis Default Factory Settings**

By default, the Mantis plays Component, 1080i and line-level audio on all channels. If your application requires the Mantis to use a different video standard and/or video output type, use the Front Panel or WebView to change the system settings as required. Consult the section on *Video Settings* on page 73 within the main body of the user manual for more information about changing these settings.

## Mantis MG Connections Guide

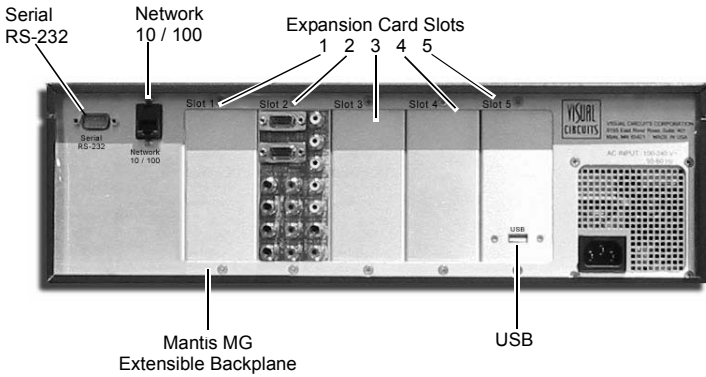

### MG Video Output Configuration

The basic configuration of the Mantis MG is two standard/high definition video channels, and three open expansion slots for future use. The MG provides multiple types of video output simultaneously, on a channel-by-channel basis. For example, it is possible to configure the MG so that Channel 1 outputs to a composite monitor, while Channel 2 goes to a component or RGB monitor. For more information on configuring video output types see the Video menu in System Settings, which is accessible from the front panel or WebView: see *Video Settings* on page 73.

#### Numbering of Channels and Expansion Card Slots

Mantis expansion card slots are numbered 1 through 5, going from left to right. The Mantis assigns channel numbers to its Gemini card or cards according to which expansion card slot the card is located.

The default configuration of the Mantis MG leaves card slot 1 open. Gemini cards begin in slot two with that card being assigned the first channel numbers. Channels on subsequent cards are numbered sequentially.

## Video and Audio Connections

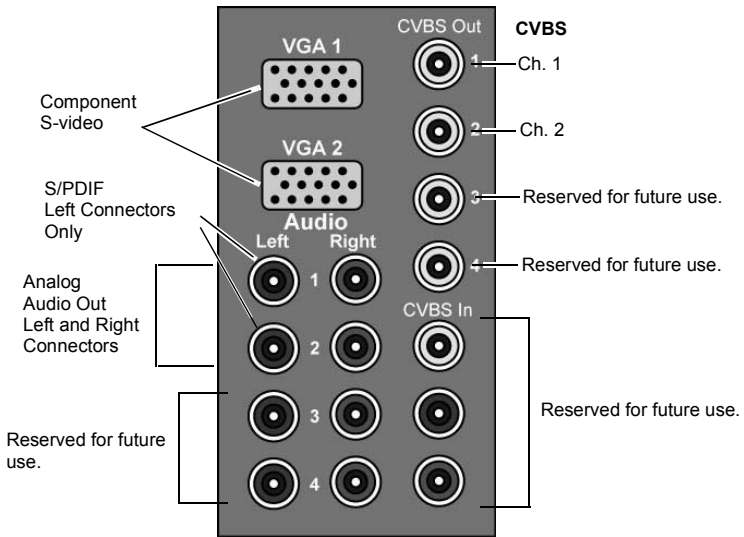

Figure 1. Mantis MG Backplane Video / Audio Connections

## Video/VGA Cable



Figure 2. Vide/VGA Cable

## CVBS

Connect a composite cable to the corresponding Channel 1 or 2 connector. The Mantis MG uses RCA-M connectors.

## Component, S-video

1. DB connector end to either VGA 1 or 2.
2. Connect the color coded cables to the appropriate connectors on the display device.

Cable	Component	S-video
Red	Pr	chroma
Green	Y	lumina
Blue	Pb	

Table 1: Mantis Cable Connections



### Termination of Audio and Video Outputs

Do not double terminate audio or video outputs, this degrades sound and picture quality.

## Audio Connections

- ❑ To create an analog stereo audio connection for Channel 1, connect a RCA-M phono-ended audio cable to the corresponding Audio Outputs Left 1 and Right 1. Repeat for Channel 2.
- ❑ To create a S/PDIF digital audio connection for Channel 1, connect a RCA-M phono-ended audio cable to corresponding Audio Output Left 1. Repeat for Channel 2.

## Configuring for a Network

Mantis default network settings are:

- ❑ IP Address: 10.0.0.1
- ❑ Network Mode: Static

To initially change the Mantis network settings, it is necessary to attach a computer directly to the Mantis.



Before beginning, verify that the computer and Mantis powered off. When connections are completed, power on the devices.

### Attaching a Laptop or PC

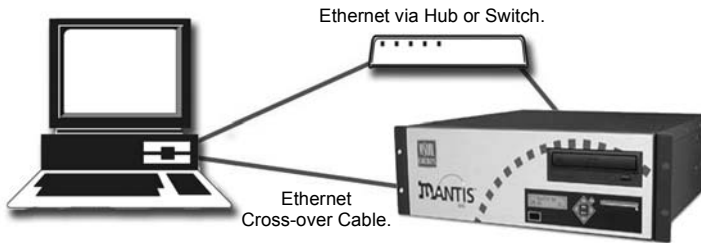

### Ethernet

- ❑ Connect the computer directly to the Mantis using an Ethernet crossover cable.
- or
- ❑ Connect using standard Ethernet cables and a hub or switch.

### Serial

Use a null modem cable (RS232, female DB-9 to female DB-9) when connecting to the Mantis via the serial port.

## Changing TCP/IP Settings

There are three methods for initially changing the Mantis TCP/IP settings: *Front Panel*, *WebView*, *Serial Commands*.

### Front Panel

The front panel of the Mantis has control buttons and a display, similar to those of a VCR, that can set most of the Mantis features and functions.

- ❑ For information about the control buttons and display, *Front Panel* on page 8.
- ❑ For information about changing TCP/IP settings, see *Step 1: Connect to the Network* on page 31.

### WebView via Ethernet Port

WebView is a browser-based, administration tool-kit that resides on the Mantis, see .

1. Set the attached PC's IP address to a number in the same range as the Mantis, such as 10.0.1.2.

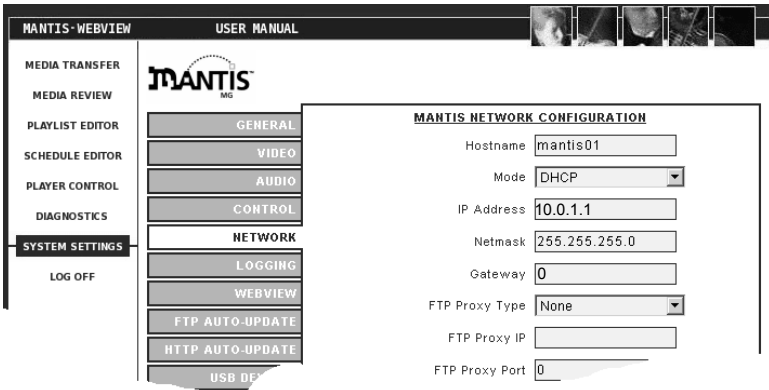

2. Open a browser and enter the default IP address 10.0.1.1 in the address field.

3. Access WebView using the default Mantis  
Login: firefly  
Password: 123456
4. Set the IP address and other TCP/IP parameters as required.
5. Click on Update Settings to save.
6. Click on Player Control.
7. Click on Restart Player.  
This initializes the new settings.



Restarting the Mantis is only necessary when updating the network settings in a DHCP environment, i.e. going from Static to DHCP mode, changing the Host Name, etc.,

## External Control Commands

External control commands, see *VCC Control Commands* on page 134, require that the computer has an ASCII generating control program, such as Hyper Terminal. The parameters are:

- Serial port 1
- 9600 Bps
- Echo typed letters locally

Use the following Visual Circuits commands to configure the Mantis.

### **FireflySetIpAddress**

Syntax  
`fireflysetipaddr IP Address`

### **FireflySetNetmask**

Syntax  
`fireflysetnetmask netmask`

### **FireflySetGateway**

Syntax  
`fireflysetgateway gateway`

### **FireflySetNetworkType**

Syntax  
`fireflysetnetworktype 1 (DHCP) or 2 (Static)`

## Front Panel

### Display

Mantis media players are designed for remote operation with unattended playback. However, the Mantis Front Panel and Display permit changing settings directly on the device. Typically, local access to the Mantis is for initial setup and installation.

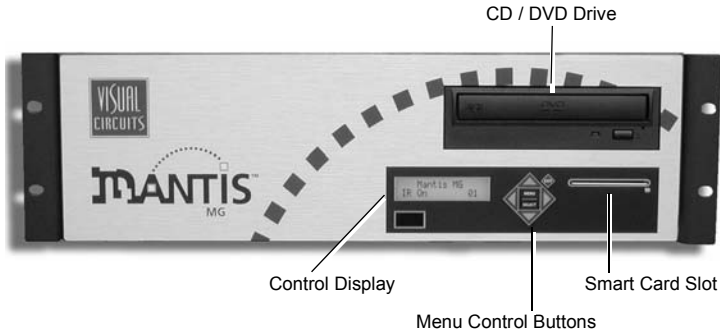
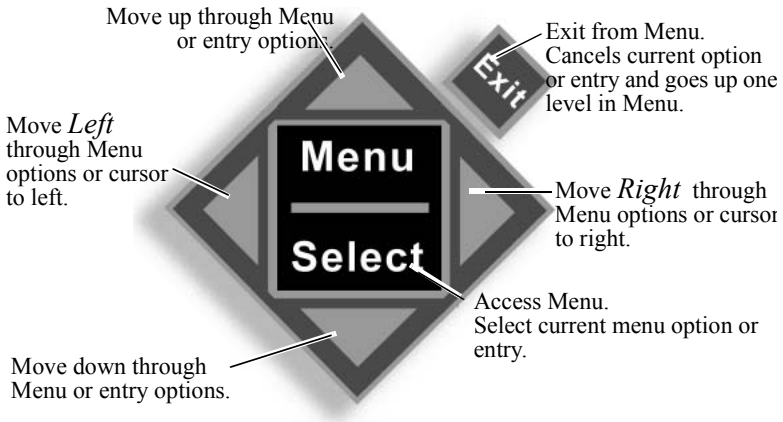

Figure 3. Front View, Mantis MG

### Menu Control Buttons



The Front Panel Buttons provide the standard type of controls found on many DVD and VCR devices.



To access the menu system, press the **MENU/SELECT** button.

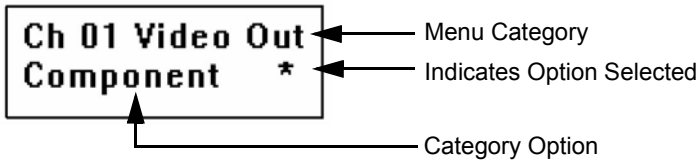

The second line of the display is also the only line that may be edited. The asterisk symbol appears to the right of a menu option when it is selected.

The **Up Menu** option allows jumping directly to the next higher menu level. When **Up Menu** is shown, press the **MENU/SELECT** and you go up one menu level.

## Changing System Settings

The Front Panel Display menu interface provides two methods for changing system settings: changing a menu option *choice* and changing a menu option *value*.

- ❑ A *choice* is an option selected from a fixed list presented by the system.
- ❑ A *value* is a parameter that is set at the discretion of the user, such as date/time, host name, or WebView user name.

See *System Settings* on page 71 for detailed descriptions of the Mantis System Settings

# Selecting a Menu Option

Use the Menu Control Buttons to view or change a menu option. The example below illustrates how to set the video output (resolution) on channel 2.

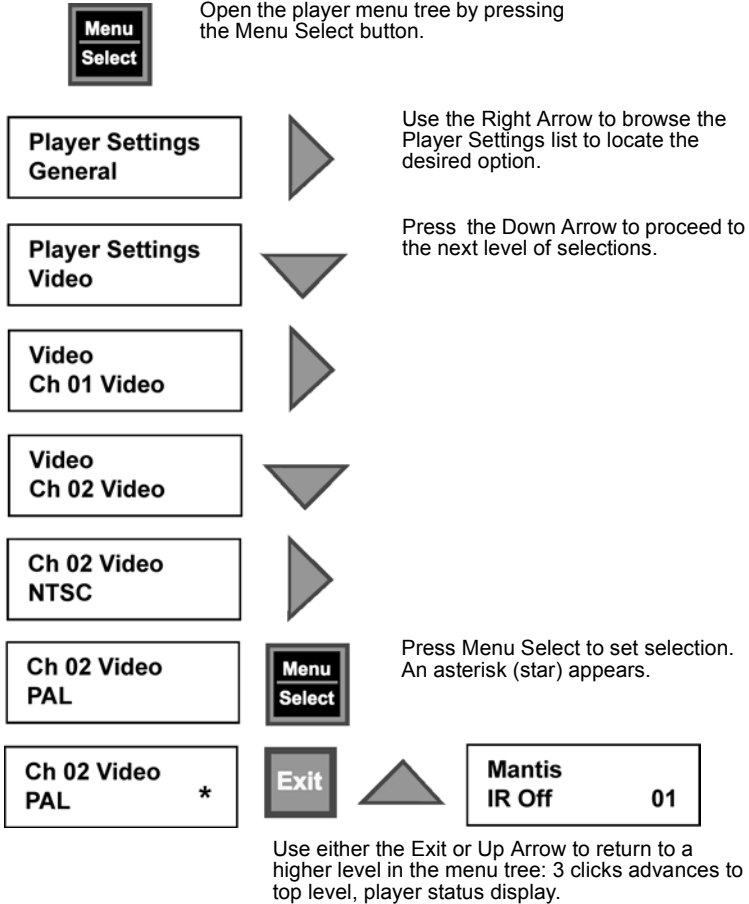

### IR (infra-red Remote Control)

The Mantis MG does not support IR Remote Control. Please disregard messages about IR.

## Changing an Option Value

Using the Menu Control Buttons to change an option value is similar to viewing or selecting the option. For example, to change the date/time value:

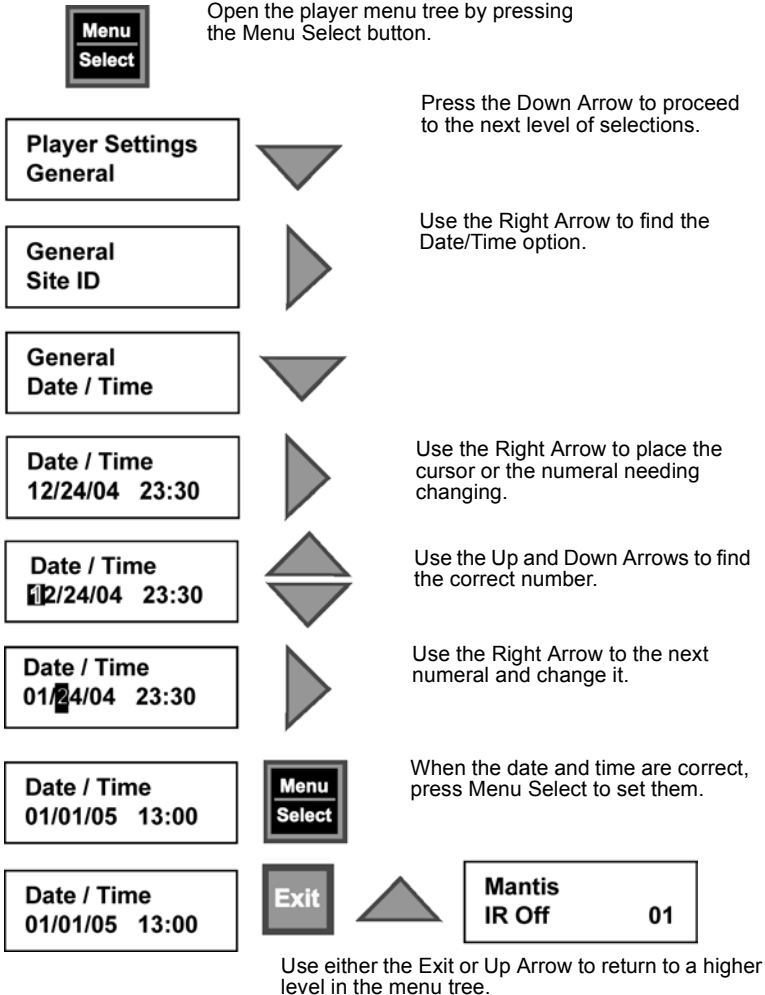



# ENCODING REQUIREMENTS AND RECOMMENDATIONS

---

Listed below are requirements and recommendations for both Standard and High Definition encoding, that provide criteria to create MPEG files compatible with the Mantis playback system.

## Standard Definition (SD) Encoding Requirements

1. Files must be one of the following types:
  - a. *program stream* MPEG2 or *transport stream* MPEG2
  - b. *system stream* MPEG1 of audio/video
  - c. *elementary stream* MPEG2
  - d. MPEG1 of video only
  - e. audio only
2. Use 4:2:0 encoding.



Do Not Use 4:2:2 encoding.

3. With MPEG-2, both audio and video fields must be encoded. This is the normal default.
4. Audio only (Dolby Digital or MPEG Layer 2) files cannot be mixed with files containing videos (MPEG, MPEG2 program stream, video only).
5. Total output across all channels can not exceed 150 Mbps.
6. The presentation time stamp (PTS) values contained in the audio and video streams in a file must be continuous and increasing.

In particular, the PTS values should not reset to 0 at any point in the file. The time between the first and last time stamps in a file should reflect the actual duration of that file.

- Files should be no less than 4 MB in size. If there are files are smaller than 4 MB, use an editor to combine them into a larger file that is at least 4 MB in size.

## SD Encoding Recommendations

- Resolution:
  - 704 x 480 or 720 x 480 in NTSC
  - 704 x 576 or 720 x 576 in PAL
- Closed GOP (Group of Pictures) with an “I-frame” every 15 frames is recommended.
- The recommended audio bit rate is 384 Kbps and a sampling rate of 48 kHz.

Before encoding an entire project, play back the test files using the original source tapes to confirm audio level. This allows for calibration of the encoding system by obtaining a standard audio level.

- Program stream files should have one end code (00 00 01 b9) at the very end of the file. While the Mantis can handle files without end codes, it is a good encoding practice to include one.
- The bit rate can affect the size and transferability of the files. Following are the recommended bit rates for various types of video content:

Bit Rate	Video Content
4 Mbps	Good quality with low motion
6 Mbps	Good quality with typical motion
8 Mbps	Good quality with high motion
10 Mbps	High quality with demanding content

**Table 1.** SD Bit Rate Encoding Recommendations

6. Although the Mantis can transcode NTSC and PAL, it is recommended to encode to the video standard (NTSC or PAL) that the Mantis is set to display.
7. When encoding files, annotate and store notes on the audio levels of both the source tape and input settings of the encoder. This permits verifying the audio levels of later encoding sessions.



Even if encoding is done at the same production facility, variances between sessions may occur and once MPEGs are encoded, the audio level of a file cannot be changed unless the file is re-encoded or a new audio track is mixed. Thus, it is desirable to maintain a baseline audio level across all files of a presentation whether at single or multiple locations. If no encoding notes or data are available from previously encoded files, compare the files. When possible, measure the audio levels of the source tapes and of the encoded files. At a minimum, listen to and compare the files.

8. MPEG files are constructed from intertwined (i.e. multiplexed) audio and video streams. If possible, the length of the video and audio stream segments within the MPEG files should be identical. Ending the audio segment at a .5 second interval (i.e., at an “I-frame”) ensures identical stream lengths and results in smooth and seamless looping playback.
9. It is recommended that SMPTE tracks should be encoded as *hot*, at approximately +6db.  
This adjustment compensates for some SMPTE information that may be lost during compression. Sample testing should be done with all SMPTE tracks because not all encoders respond in the same way.
10. For reference and calibration, encode into the MPEG files the standard color bars and audio test tones along with the content or source files. These encoded display test and audio tuning files should be separate files, not headers or footers of the presentation.

11. To play back still images or computer-based graphics, hardware-based encoding systems are preferred. However, if a software encoder is needed, we recommend encoders such as DVMPEG ([www.darvision.com](http://www.darvision.com)).



Multiplexing a blank audio track on all video-only MPEG files is highly recommended.



# High Definition (HD) Encoding Requirements

Failure to follow the encoding guidelines may result in issues such as uneven playback, blocky output, or frozen video.

1. The HD encoding format supports Transport Streams and Program Stream MPEG 2 files of audio/video or video-only files, or audio-only (Elementary Stream) files. All 18 of the standard ATSC digital television formats are supported.
2. Audio compression formats:
  - Dolby Digital (AC3)
  - MPEG 1 2-channel layers I and II
  - MPEG 2 2-channel Layer II
3. Audio sampling rate of 48 kHz.
4. Frequency response is 20 Hz – 20 kHz +/- .5 db
5. Audio output level up to 4v p-p
6. Audio output impedance 620 Ohms
7. When creating a playlist of videos, all files to be played in a single playlist must have a common Program Identification (PID) for the audio stream, as well as a common PID for the video stream. In addition to having the same PID, the files in the same playlist should also have the same audio format as well (example: either Dolby Surround, MPEG-2 or elementary video only with no audio data).
8. The video and audio data streams in each file should be as close to the same length as possible, exact length is preferred, and beginning and ending at the same time stamps.

## HD Encoding Recommendations

1. The recommended encoding bit rate is a minimum of 10 Mbps. The standard broadcast rate is 19.4 Mbps. The maximum total bit rate is 40 Mbps. The audio and video PES IDs (PIDS) can be set in software for multi-stream applications.
2. When encoding it is recommended to:  
Set Video PID: e0 (hex-decimal: 224)  
Set Audio PID: c0 (hex-decimal: 192)  
Standardizing all PIDs ensures that all files may be played back to back with only minimal adjustments.
3. Audio/video streams cannot be mixed with video-only on the same channel during playback. It is recommended to encode an audio track with “tone” if there is no audio present on the source tape. This will standardize all MPEG files and provide easy future management of video content.
4. It is recommended that files be at least 30 seconds in length.
5. If files are to be used in cross-channel synchronization, it is recommended that the files begin with 3-4 seconds of black at the beginning to allow the files to sync up with each other.

## Encoding Software

Use applications such as *Pixel Tools* ([www.pixeltools.com](http://www.pixeltools.com).) and *VIDEO CLIPPRO* ([www.vitecmm.com](http://www.vitecmm.com)) for post-production work. These guidelines are meant to serve only as information for professional video studios that do their own encoding.

### Pixel Tools

This software creates a video-only transport stream from an AVI file or an animation sequence of BMP, TGA or TIFF images.

- ❑ *Pixel Tools* can add an audio track with its transport multiplexor and audio encoder.

## Video Clippro

*VIDEO CLIPPRO* from Vitec Multimedia ([www.vitecmm.com](http://www.vitecmm.com)) transcodes between program and transport streams. The multiplexor on this program can also be used to include audio data on files.

- ❑ Orient or rotate all files if the HD playback monitor is running vertically as opposed to standard horizontal positioning.

## Focus Enhancements

Focus Enhancements does not provide technical support for parties doing their own software encoding, nor provides technical support for those using either *Pixel Tools* or *VIDEO CLIPPRO*.

Focus Enhancements does provide comprehensive encoding services, including High Definition.

Please visit our website at [www.visualcircuits.com](http://www.visualcircuits.com) or call 1-800-250-5533 for details.



# SMART CARD

---

## Overview

The Smart Card is a plastic card with an imbedded microchip that contains data or code for use by an application.

Visual Circuits uses Smart Card technology to license optional features for Mantis media players and to save their system setting configurations.

## Optional Features

Licensing via Smart Card permits the purchase and use of individual Mantis features.

<b>Optional Smart Card Features</b>
Multicast
Additional Channels
3 or More

**Table 1.** Optional Mantis MG Features

As new product enhancements and updates are released, they are made available, as upgrades to the Smart Card.

## Saving and Loading System Setting Configurations

The Smart Card facilitates easy setup and configuration of multiple Mantis media players. Setup one Mantis and copy its system settings configuration to the Smart Card. Then, insert the Smart Card into another Mantis and load the data. The Mantis detects the new system settings and changes any of its settings to match the configuration stored on the Smart Card.

## Using the Smart Card

The Smart Card reader slot is located directly below the DVD/CD drive.

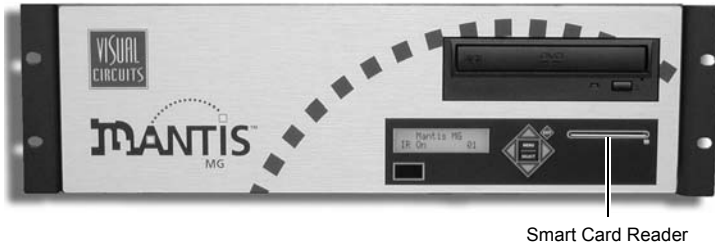

## Inserting the Smart Card

To insert the Smart Card:

1. Orient the card so that the label is facing up and the arrow points into the Smart Card reader slot.
2. Insert the card into the reader until the card is seated.  
A green status light indicates that the card is installed correctly.

## Saving a Configuration to the Smart Card

To save a system settings configuration to the Smart Card, use either the WebView or the front panel interface.

### Using WebView

To save the current configuration of system settings to the Smart Card:

1. Click on **System Settings** from the menu options on the left.
2. Click on the Smart Card tab.
3. Click on the **Save Config** button.

The Mantis saves its system settings to the Smart Card.

### Using the Front Panel

To save the current configuration of system settings to the Smart Card:

1. Press the **MENU/SELECT** button.
2. Use the **Left** and **Right** arrow buttons to locate the Mantis Settings.
3. Press the **Down** arrow button to proceed to the Smart Card options.
4. Use the **Right** arrow button to move to **Save Config**.
5. Press the **MENU/SELECT** button to save the configuration.
6. Use either the **MENU/SELECT** or **Up** arrow buttons to advance upward through menu until at the top, system status, level.

## Loading a Configuration from the Smart Card

To load a system settings configuration from the Smart Card use either the WebView or the front panel user interface.

### Using WebView

To load a system settings configuration from the Smart Card:

1. Click on **System Settings** from the menu options on the left.
2. Click on the Smart Card tab.
3. Click on the **Load Config** button.

The Mantis loads the configuration data from the Smart Card.

### Using the Front Panel

To load the system settings configuration from the Smart Card:

1. Press the **MENU/SELECT** button.
2. Use the **Left** and **Right** arrow buttons to locate the Mantis Settings.
3. Press the **Down** arrow button to proceed to the Smart Card options.
4. Use the **Right** arrow button to move to **Load Config**.
5. Press the **MENU/SELECT** button to load and save the new configuration.
6. Use either the **MENU/SELECT** or **Up** arrow buttons to advance upward through men until at the top, system status, level.



## Eject the Smart Card

Use the front panel to remove the Smart Card from the Mantis.

### Using the Front Panel

Press the **EXIT** button for five seconds and the Mantis ejects the Smart Card.



If the Smart Card is inserted incorrectly and the green status LED does not light, Press and hold the **EXIT** button on the Mantis front panel for 5 seconds to eject it.

## If Smart Card Does Not Eject

In the event the Smart Card does not eject, refer to *Smart Card does not eject*, page 202 in the Troubleshooting section for more information.

## Storing the Smart Card

The Smart Card is a digital medium storage device and as such should be handled and stored using common ESD procedures.



In the event a Mantis needs servicing, do *not* send its corresponding Smart Card back with the unit.

Keep the Smart Card safely stored to avoid potential loss or damage.



## Overview

WebView™ is a web-based application that provides access to a Mantis over a network using conventional web browser technology. WebView is compatible with Microsoft Internet Explorer™ 5.5 and later. While WebView may work with other web browsers, Focus Enhancements does not guarantee full compatibility.

WebView is a suite of content and device management tools:

1. **Transfer Media** *page 36*  
Use this FTP application to move media content, playlists, and schedules back and forth between the Mantis and the host computer.
2. **Media Review** *page 39*  
Use this file management application to review directory contents, preview video and graphic content, and delete all files stored on the Mantis.
3. **Playlist Editor** *page 42*  
Use this editor to create and maintain video playlists. In addition design playback by adding graphic overlays.
4. **Schedule Editor** *page 50*  
Use this editor to create and maintain playlist playback schedules. Control when, where, and how often a playlist runs.
5. **Player Control** *page 61*  
Use this control to play, pause, stop files on a channel-by-channel basis. Select and play videos within a playlist.

## 6. **Diagnostics** *page 62*

These pages provide statistics for a variety of system activities:

### a. General

Includes revisions of hardware/software in use, currently loaded playlist and schedule by channel, last updates, number of system starts, and number of Watchdog restarts.

### b. Video

Video data by channel that includes horizontal and vertical size, video and audio bit rates, audio frequency, frame rate, current frame, timecode, and file type.

### c. Playback

Provides data flow information by channel, such as interrupts, last sync, and disk and data underflows.

### d. Logging

Mantis provides two types of logging: Run and Diagnostic. These logging functions supply information collected by the Mantis during its operations, including FTP/DVD updating times with files and their sizes, records of files removed during house-keeping operations, lists of any missing media associated with active playlists, record of serial commands received and sent, and an error summary.

## 7. **System Settings**

Use this page to view system and network settings.

# Accessing WebView

## Step 1: Connect to the Network

Both the Mantis and the PC with the web browser must be on a common network. For information specific to your network contact your Network Administrator.



### **Security Warning**

If using WebView over the Internet, the user's network must provide all the security: the Mantis does not include any special security features.

## Step 2: Determine the IP Address of the Mantis

After confirming network connections for both the Mantis and the web browser computer, it is necessary to determine the IP address or DNS name of the Mantis.

### IP Address (static)

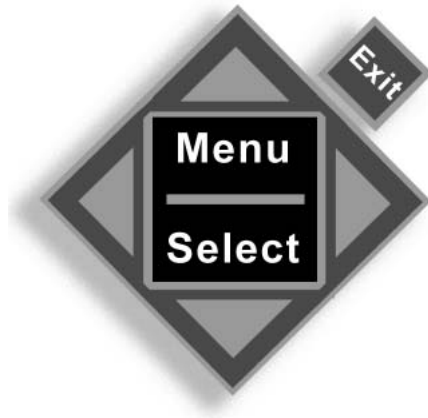

To obtain the IP address, use the **Menu Control Buttons** on the Mantis front panel:

1. Press **MENU/SELECT** to display the main menu.
2. Press the **Down** arrow once to select **Player Settings**.
3. Use the **RIGHT** arrow to find **Network**.
4. Press the **Down** arrow once to proceed to the network settings list.
5. Use the **RIGHT** arrow to find **IP Address**.
6. Press the **Down** arrow once to display the Mantis IP address.
7. Write down the address.
8. Press **Exit** several times until out of the menu.

---

## Dynamic IP Address (DNS and DHCP)

If the network uses dynamic IP addresses, determine the address:

1. Press **MENU/SELECT** to display the main menu.
2. Use the **DOWN** arrow key to move to **Player Settings**.
3. Use the **RIGHT** arrow to move to **Network**.
4. Press the **Down** arrow to proceed to the network settings level.
5. Use the **RIGHT** arrow to move to **Mode**.
6. Press the **Down** arrow to go to mode level.
7. Use the **Right** arrow to select **DHCP**.
8. Press the **Down** arrow to display the dynamic IP address assigned to the Mantis.



If the network employs DHCP it is not necessary to know the IP address to access a particular device. Instead enter the device host name: such as *http://hostname* or *http://hostname.yourdomain* where hostname or hostname.domain represents a specific name assigned to the device when it was installed on the network.

9. Record the IP address.
10. Press **EXIT** repeatedly until out of the menu system.

## Step 3: Establish Communications with the Mantis

Launch an Internet browser program and enter the IP address or DNS name in the address field.

When contact is established, a login screen appears.

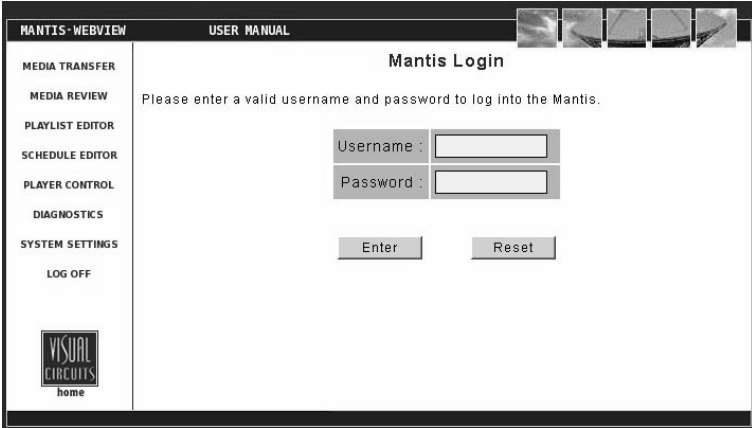

Figure 1. WebView Login Page

## Step 4: Enter User Name and Password

Both the user name and password are case sensitive and require a minimum of 6, but no more than 30, characters.

All Mantis ship from the factory with the default user name of *firefly* and the default password *123456*. If the defaults do not work, contact your Network Administration for the correct username and password.



### Security Warning

Default user names and passwords are a favorite tool of hackers. Because many people never change the default usernames and passwords, they are given, it is easy for hackers to learn them and then try them on every similar product they find.

Your first layer of security is always to change the default login settings immediately.



# Using WebView

All WebView pages have a similar layout.

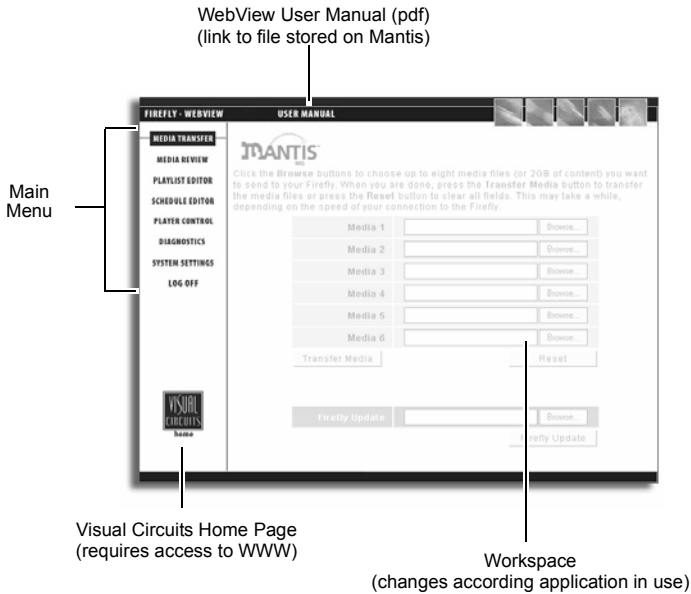

**Figure 2.** Typical WebView page layout

The default starting point in WebView is the Media Transfer page as the default starting point, page 36.



### **Warning: Only Use WebView Main Menu Buttons**

Do not use the Internet Explorer “History” function or its Backward / Forward navigation buttons within WebView. For WebView to refresh its displays with current data, it must query the Mantis player. Using the Internet Explorer history or navigation buttons pulls old data from the browser cache and does not issue a fresh query for data to the Mantis. This can cause inconsistent results.

## Transferring Media

Use this page to transfer media from the work computer or network to the Mantis. Webview can transfer up to six media files at once.

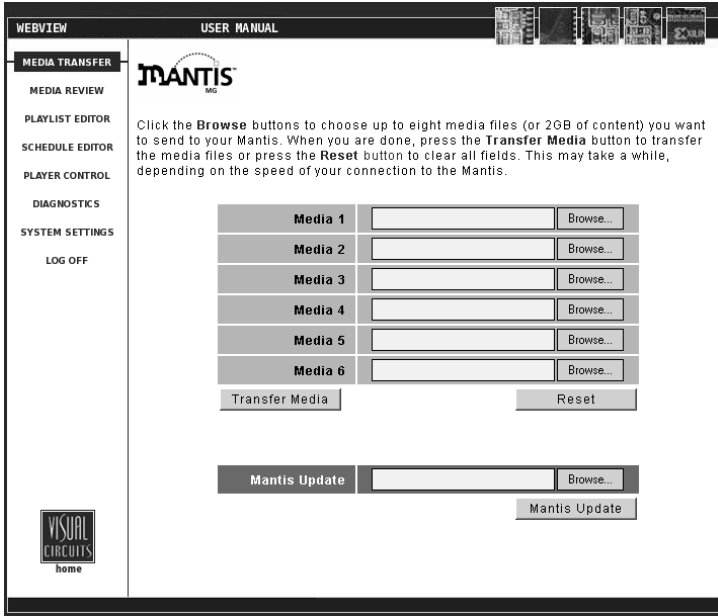

Figure 3. Webview Media Transfer Page



### Do Not Close or Change Web Pages while Transferring Files

If you close or select another web page during a media transfer, the transfer will terminate. If you would like to multi-task during a transfer, you may open a new web browser and log in.

1. Use the six browsing fields, Media 1 through 6, to locate and identify the files to transfer.

The Webview browse function provides the ability to search local and network hard drives for needed files.

- After selecting the media files to transfer to the Mantis, click the **Transfer Media** button to start the transfer. Clicking the **Reset** button clears all selections. Mantis indicates that the file transfer is proceeding by displaying an animated sequence of flashing circles in the lower left portion of the page, where the Visual Circuits logo normally appears. The length of time required for the transfer depends on the size of the files and the transfer rate of the network. Transfers can take several minutes.
- After WebView has successfully transferred all of the selected files, the Mantis displays a summary page showing a list of the files uploaded.

Name	Type	Size
LogoSpin.m2p	video/mpeg	5.46MB
Large.BMP	image/bmp	338.55KB
PoweredBy_AC3.VOB	video/mpeg	10.88MB
colorbars75percent.m2v	video/mpeg	7.06MB
multiburst&100hz.mpg	video/mpeg	20.32MB
slide1.m2v	video/mpeg	7.67MB

Transferred 6 files totaling 51.72MB in 25 seconds. (2.07MB/s)

**Figure 4.** WebView Media Transfer Summary Page

- Return to the Media Transfer page and repeat the process if there are more files to transfer.

## Graphic File Transfer and Conversion

The image formats that are compatible with WebView and Media Messenger are .bmp, .gif, .jpg, .png, and .tga.

When WebView transfers an image file to the Mantis, it converts the file to a standard 24-bit format and automatically determines the correct image size for the selected output standard, for example 720 x 480 for NTSC. The Mantis stores the original image and uses it as the thumbnail that is displayed in the various WebView editing windows.



### Image Resolution

The Mantis conversion of the graphic image does not change the image resolution.

If extremely precise control of image size and color is required, it is necessary to edit the file and convert it to the 24-bit bmp prior to transferring it to the Mantis.

## Webview Software Update

1. Download the Webview Update file (.upd) from Visual Circuits web site and save it on the work computer. This file is also available via CD.
2. Locate the UPD file using the **Mantis Update** field at the bottom of the Media Transfer screen.
3. Click **Mantis Update**.  
After the file transfers to the Mantis, the system immediately begins to process the update. This takes approximately one minute. The Mantis then automatically restarts.
4. Once the restart completes, verify that the system version has changed. This indicates that the update is a success.

## Media Review

The WebView Media Review page, provides the ability to review media and storage usage on the Mantis, preview video and graphic overlay media, and delete media from the Mantis. By default, the data displayed are: video, overlay, playlist, and schedule.

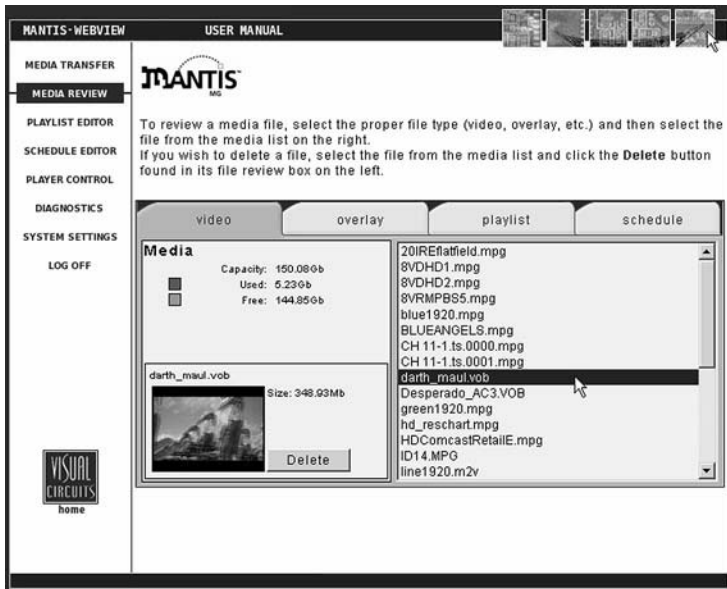

Figure 5. WebView Media Review Page



If an optional Smart Card application such as MultiCast is running, its data appears on the Media Review page too.

## Viewing Media and Storage on the Mantis



**Figure 6.** Detail of Media Review Video and Overlay Pages

Use the Media Review page to view the video and graphics overlay files and directory listings for video, graphics overlay, playlist, and schedule files that are currently stored on the Mantis.

To review a file:

1. Select the tab that represents the file type.
2. Select the file from the list on the right.

The media review box on the left displays:

- Maximum storage capacity
- Storage Used and Free
- Filename with extension
- File size in MBs
- If the file is a video or an overlay, a thumbnail of the video or image displays, along with the file size
- If an overlay is selected, its resolution is also shown
- There is a **Delete** button for removing files

---

## Thumbnail Videos

The first time a video displays in the preview area there is no animated sequence available for preview playback. Click the Preview Button to have the Mantis create a short animated sequence using thumbnail stills from the video. This animation is stored and retrieved automatically for future previews.

Once the thumbnail animation is created, the Preview Button ceases to display for that specific media file,



In some cases, video and graphic overlay files may not display in the preview window.

## Deleting Media from the Mantis

1. Select the proper tab: video, overlay, playlist or schedule.
2. Select the file(s) from the media list on the right.  
To select several files at the same time, use the standard Windows **Shift/Control** method.  
The media review box on the left displays the name of the file and its size (in MBs).  
In cases where several files are selected, all of the file names appear along with a total of their combined sizes.
3. Click the **Delete** button.



### WARNING

#### Deleting Files While in Use by Current Playlist

This deletion process works for all media files stored on the Mantis and it is possible to remove files required by the current playlist.

If a file that is currently playing is deleted, it is allowed to finish playing before the file is actually removed. The next time it is called by the playlist it will be skipped.

There is no way to retrieve files once they are deleted.

## Using the Playlist Editor

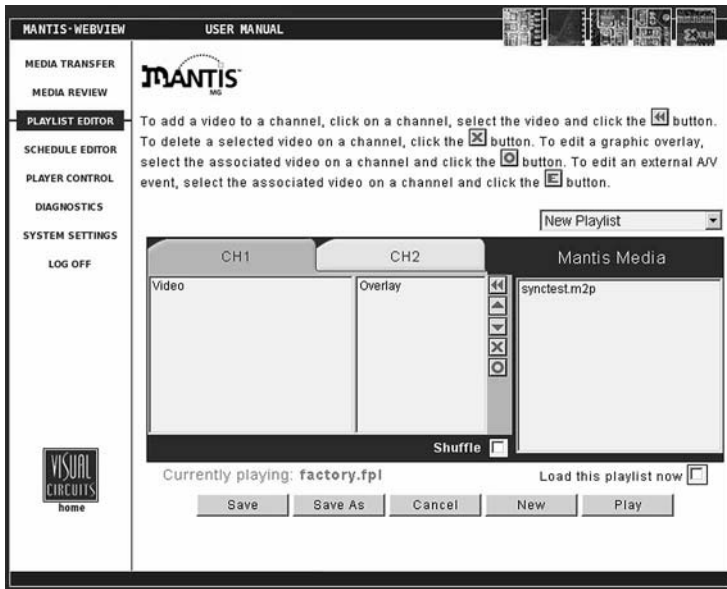

**Figure 7.** WebView Playlist Editor Page

Use the Playlist Editor to create or modify a video playlist by:

- ❑ Arranging videos in a playback sequence
- ❑ Creating and positioning graphic overlays associated with specific videos

The graphic overlay feature provides an effective way to display a company logo, sale sign or other static image (.bmp, .jpg, .gif, .tga or .png) over a video. Within the playlist, it is possible to assign a graphic overlay to one, many, or all videos in the list.

Once created, a playlist is available for immediate playback or its file can be stored for future use.



---

## Creating a New Playlist

There are two methods for creating a new playlist: by choosing **New Playlist** from the Playlist drop down menu or by clicking on the **New** button in the lower right corner.

## Adding Videos to a Playlist

To add video files to a playlist:

1. Select the channel tab to work with.
2. Browse the Mantis Media list to locate the video to add.
3. Select the video(s) and then click on the  button located on the center buttons panel.



Add multiple videos using the Windows **Shift/Control** method.

Newly added files appear at the bottom of the list for that channel or, if a file is highlighted, below it.

Once listed, a video can be used multiple times on the same or different channels.

## Removing Videos from a Playlist

To remove video files from the playlist:

1. Select the video(s) in the Video listbox.
2. Click on the  button located on the center buttons panel.





Remove multiple video files using the Windows **Shift/Control** method.

If a video is listed on several lists, removing it from one list does not remove it from the others.

## Moving Videos Within a Playlist

To move a video up or down within a playlist:

1. From the Video list, select the video to move.
2. Click the  to go up or the  to go down within the playlist.
3. Move the file to the desired location in the playlist.

## Shuffling Video Playback on a Channel

The **Shuffle** feature offers the ability to playback a playlist's videos in random order.

- To turn Shuffle On, place a check mark in checkbox located at the bottom right of the channel tab area. To turn Off, remove the check mark.
- Shuffle is set on a channel-by-channel basis. Thus it is possible to Shuffle videos on a single or multiple channels.

## Adding Graphic Overlays to a Playlist

Adding a graphic overlay file to a playlist is similar to the process for adding video files.



A graphic overlay is the attribute of a video, hence an overlay can not be added to an empty channel.

A video can have only one graphic overlay. If a second graphic is added, it replaces the first.

There are two ways to add a graphic overlay to a video.

The first method is:

1. Click on the video that is to have the overlay to associated with it.
2. Locate and click on the graphic that is to be the overlay.
3. Click on the  button to add the graphic as an overlay.

The graphic overlay appears in the Overlay list on the same line as the video to which it is associated.

---

To modify a graphic overlay's properties, select either the video or the graphic overlay and then click the  button. This displays the Graphic Overlay Properties page, see the next section for more details.

The second method permits reviewing and adjusting the graphic overlay properties before saving it:

1. Click on the video that is to have the overlay associated with it.
2. Click on  button to display the **Graphic Overlay Properties** window.
3. Click on the **Overlay Filename** drop down menu to locate and select the graphic that is to be the overlay from the Media list.
4. Review and/or adjust the overlay properties, see the next section for details on this.
5. Click the **OK** button.

The graphic overlay now appears across from its associated video in the Overlay list.

## Working With Graphic Overlays in a Playlist

When WebView transfers an overlay image file to the Mantis, it converts the file to a standard 24-bit format and automatically determines the correct image size for the selected output standard, for example 720 x 480 for NTSC. The Mantis stores the original image and uses it as the thumbnail that is displayed in the various WebView editing windows. .



### Image Resolution

The Mantis conversion of the graphic image does not change the image resolution.



An alternative to the auto-formatting performed by the Mantis is to create the image and convert it to the 24-bit file mentioned above before transferring into the Mantis.

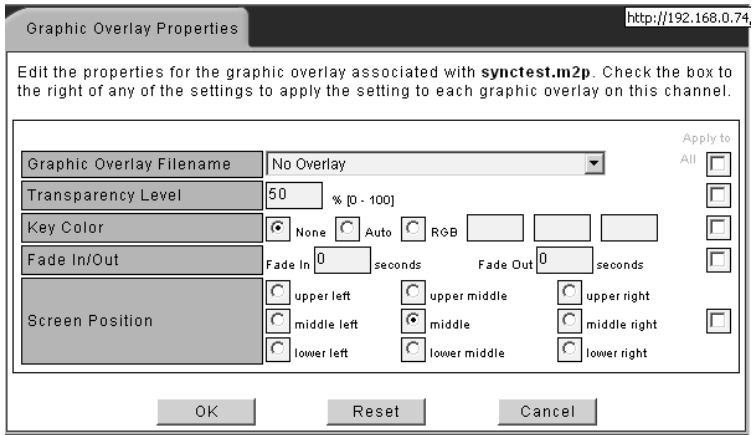

**Figure 8.** Graphic Overlay Properties Page

The process for altering the characteristics of a specific graphic overlay is as follows:

(Skip steps 1 and 2 if a graphic overlay is selected and the Graphic Overlay Properties page is displayed).

6. Select the video that the graphic overlay is to be associated with and click on the  button to display the **Graphic Overlay Properties** page.
7. Click on the **Overlay Filename** drop down menu to locate and select the graphic overlay from the Mantis Media list.
8. Select a level of transparency between 0 and 100%.  
Transparency is the extent that the graphic overlay allows the video beneath it to show through. Select between 0% (opaque) to 100% (clear). The default is 0%.
9. If desired, adjust the Key Color.  
Called Masking, Blocking, Cropping, or Keying Out, use the Key Color to specify which color within the graphic becomes invisible, and thus allows the video to show through. There are three methods for selecting a color to key out.
  - None** - No color selected. This is the default setting.

- ❑ **Auto Key** - Mantis assumes that the color in the upper left corner of the graphic is the background color and selects it to key out.

**Removing Residual Background Color**

The best backgrounds to key out have a single, uniform color with no pattern. If, after using Auto Key, there is still a residual color, i.e. specks of the background remain, then use RGB.

- ❑ **RGB** - Manually select the color to key out by entering its RGB (Red, Green, Blue) values into the designated fields.
10. If desired, adjust the time (in seconds) at which the graphic overlay fades in and/or out on the screen.

**Fade Times and Apparent Fade Rates**

A complete fade from solid to invisible goes through 16 levels of transparency. An overlay's *apparent* rate of fading depends on its transparency. Example: two overlays, one solid and the other 60% transparent fade are set to fade out in 5 seconds. They do, but the solid *appears* to fade faster because it goes through more levels of transparency.

11. If desired, select the position on the screen to place the graphic overlay, example, bottom-left.
12. If desired, use the check boxes on the right side of the screen. The check boxes correspond to each of the graphic overlay properties. These check boxes can be used to copy the properties in their associated frames to all of the existing graphic overlays across all channels in a playlist. For example, to ensure that all existing graphic overlays for a given playlist always appear in the lower right corner, set the screen position attribute to right bottom and check the **Apply to All** box to the right of that frame. This may be done for some or all of the of a graphic overlay's properties.
13. Click the **OK** button to save the changes and to return to the Playlist Editor screen.

## Saving a Playlist

When finished editing the playlist, save it by clicking either the **Save** or **Save As** buttons at the bottom of the screen.

- ❑ Clicking **Save** overwrites the original playlist file using the same filename.
- ❑ Clicking **Save As** provides the opportunity to save the playlist with a new filename.

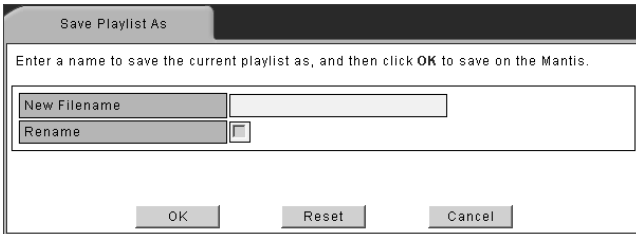

**Figure 9.** WebView SaveAs Dialog Box



### Filename Conventions

The Mantis provides three interfaces, that allow the creation and naming, or transferring of files: front panel controls, WebView, and External Control Commands. To insure compatibility between them, filenames must conform to the following conventions:

- up to 214 alphanumeric characters (capitals and lowercase) in length
  - can include spaces dashes, and underscores
  - can begin with either alpha or numerical character
- ❑ After entering the new filename.
  - ❑ Click on the **Rename** check box.
  - ❑ Click **OK** to save the renamed playlist and to return to the Playlist Editor page.
  - ❑ If there is a check mark in the **Load this playlist now** check box , found below the Mantis Media list, the modified playlist begins playing as soon as it is saved. The box is not check marked, the playlist is saved, but playback does not start until the playlist is later selected for playback.

## Playing a Playlist Quickly

To play a playlist at once, click the **Play** button, located in the lower right portion of the Playlist Editor screen. This overwrites the original playlist file using the same file name and begins designated playback on the Mantis immediately.

## Using the Schedule Editor

The Schedule Editor has two workspaces; the Playlist Events Editor and the Video Dates Editor. By default, the Playlist Events Editor displays first.

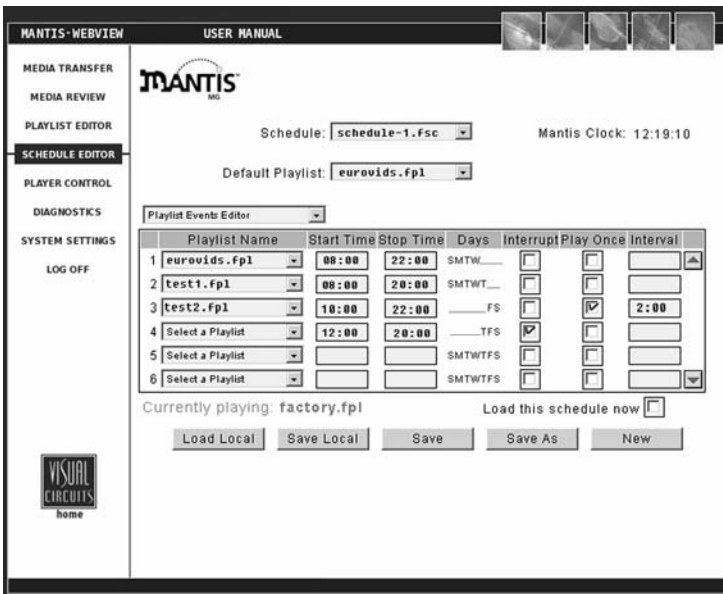

**Figure 10.** Schedule Editor - Playlist Events Editor Page

Use the Playlist Events Editor to create or update a schedule by defining which playlist or lists are in the schedule and setting the playlist's playback properties.

In addition, the Video Dates Editor permits the setting of specific start and stop dates for individual videos in the playlist. The Video Dates Editor is accessed via the Playlist Events Editor.



### **Do Not Include Empty Rows in the Playlist Events Editor**

When creating or editing a playlist, do not leave an empty row between playlist names. Gaps between playlist names will result in lost data when the file is saved.



## Creating a New Schedule

There are two ways to create a new schedule.

- ❑ Select **New Schedule** from the Schedule drop down menu
- ❑ Click on the **New** button in the lower right corner

The Playlist Events Editor provides options to:

- ❑ add an event to a schedule
- ❑ delete an event from a schedule
- ❑ edit an event within a schedule

In addition, by using the Video Dates Editor, it is possible to assign date rules to individual videos.

Each of the major tasks in the Playlist Events list involve adjusting the event property fields. The following table provides basic overviews and examples for each of the event property fields:

Property	Description
<b>Playlist Name</b>	Designates which playlist to play. Example: "I want my product demonstration playlist selected to play".
<b>Start Time</b>	Designates time to start playing playlist. Example: "I'd like to have my playlist start playing at 9:00".
<b>Stop Time</b>	Designates time to stop playing playlist. Example: "I'd like to have my playlist stop playing at 18:00".
<b>Days</b>	Designates days of week to play playlist. Example: "I'd like to have my playlist play only on Thursdays, Fridays and Saturdays"
<b>Interrupt</b>	Option to cut off video playing in previous playlist instead of waiting for video to finish playing. Example: "I'd like to have the video in my sales promotion playlist interrupt the video in my product demonstration playlist"
<b>Play Once</b>	Option to play playlist exactly once and then return to previously scheduled playlist. Example: "I'd like to play my one hour specials playlist just once during the business day"
<b>Interval</b>	Option to repeat a "play once" event periodically at a specified interval. Example: "I'd like to play my one hour specials playlist once every 2 hours throughout the business day"

**Table 1:** Schedule Event Properties

## Adding or Editing an Event

The processes for adding or editing an event are similar with one exception. Adding an event requires selecting a playlist not in the schedule while editing requires working with an event listed in the schedule.

To add an event to a schedule:

1. In the Playlist Name column, go to the first empty field.
2. Open the field's drop down menu and select a playlist.
3. Edit the event properties as described below.
  - a. **Playlist Name:** Choose a playlist from the **Select a Playlist** drop down menu.
  - b. **Start Time:** Set the specific start time for the playlist using the number keys on your keyboard.
  - c. **Stop Time:** Set the specific stop time for the playlist using the number keys on your keyboard.
  - d. **Days:** Click on any of the days to display the **Days of the Week** dialog box.

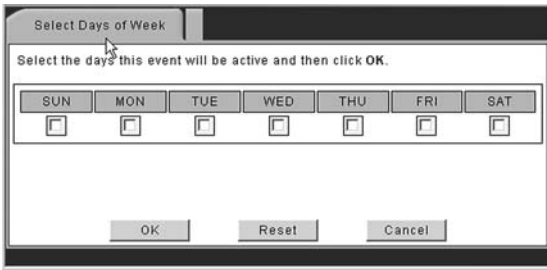

**Figure 11.** WebView Days of the Week Dialog Box

- Click on which days of the week the playlist is to play on. A check mark in the box indicates the day is selected.
- To clear all of the day selections, click the **Reset** button.
- When done, click the **OK** button to return to the Schedule Editor screen.

- e. **Interrupt:** Click on the **Interrupt** check box to have the first video in a playlist start playing precisely at its scheduled time and interrupting whatever playlist and video that is playing then. This feature is useful for time sensitive playlists.
  - f. **Play Once:** Click on the **Play Once** check box to choose to have a playlist played back only once: regardless of Start/ Stop time settings that would permit looping.
  - g. **Interval:** Use the number keys on the keyboard to enter a periodic time interval (HH:MM). This is the length of time between Play Once event for the playlist.
4. Assign specific start and stop playback dates to particular videos in the playlist, see *Assigning Dates for Video Playback* on the next page.
  5. When finished editing the schedule, save it using the instructions found in *Saving a Schedule* on page 57.

## Assigning Dates for Video Playback

Use the Video Dates Editor to designate the date(s) a particular video is to play. Create a date rule for when a particular video is to playback by selecting its start date, or end date, or both.

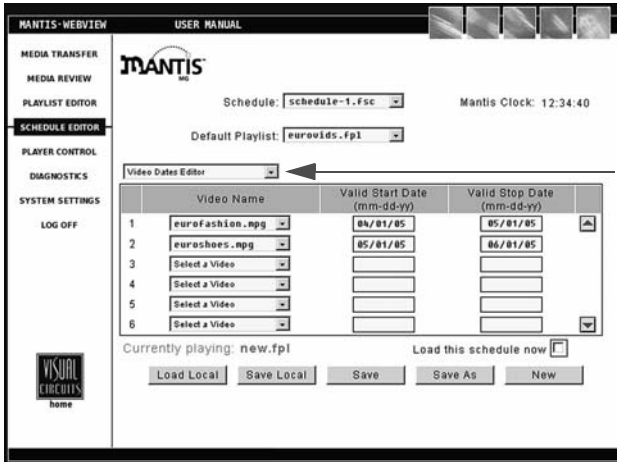

Drop down Menu  
Playlist Events  
Video Dates

**Figure 12.** Schedule Editor - Video Dates Editor Page

Depending on the application, a video may use any or all of the three date rules. The table below provides examples for using the Video Dates Editor. .

Start	Stop	Description
03/01/05	--/--	Start date with no stop date. Example: "I want my product demonstration video available to playlists the day the product is released, but no sooner than that".
--/--	03/01/05	No start date with stop date. Example: "I want my new marketing campaign video available to playlists from now until the end of the spring months"
03/01/05	03/31/05	Both start date and stop date. Example: "I want my March promotions video available to playlists only during the month of March.

**Table 2:** Video Date Rule Examples

**Add or Edit a Date Rule to a Video**

1. In the **Playlist Events** workspace, select the playlist that contains the video requiring date rule editing.
2. Select the **Video Dates Editor** from the drop down menu.  
The process for adding or editing date rules is the same with one exception. Adding rule first requires selecting a date not already in the list. Editing an date rule requires the listed date and modifying the rule.
3. From the **Select a Video** drop down menu, choose the video to receive the date rule.
4. Set the appropriate start and/or stop dates. These dates must be in numerical format.
5. Repeat steps 2 through 4 to add date rules to additional videos if desired.
6. When the date rules are completed, save using the instructions found in *Saving a Schedule* on page 57.

**Delete a Date Rule for a Video**

1. From the **Playlist Events** workspace, select the playlist that contains the video requiring date rule editing.
2. Select the **Video Dates Editor** from the drop down menu.
3. In the Video Name list, locate the video with the date rule to delete.
4. Change the video to **Select a Video** from the Video Name drop down menu. The date rules are deleted.
5. Repeat steps 2 and 3 to delete date rules for additional videos if desired.
6. Save changes using the instructions found in *Saving a Schedule* on page 57.

## Deleting an Event from a Schedule

To delete an event from a schedule, use the following steps:

1. Verify that the correct playlist is being edited.
2. Locate the event to delete.
3. Manually clear all of the event's properties, including any date rules set in the Video Dates Editor.
4. In the **Playlist Name** drop down menu, choose **Select a Playlist**.  
When done, this will delete the playback event and its associated properties from the schedule.
5. When finished editing the schedule, save it using the instructions on the next page.

## Saving a Schedule

When finished editing the schedule, save it by clicking either the **Save** or **Save As** buttons at the bottom of the screen.



### Saved Changes Take Effect Next Time Schedule Reloaded

When a schedule is saved, its playlists are saved in their entirety within the schedule file. For playlist changes to take effect, the schedule must be reloaded to the Mantis.

1. Clicking **Save** overwrites the original schedule file using the same file name.
2. Clicking **Save As** provides the opportunity to save the schedule with a new filename, see *Filename Conventions* on page 48.

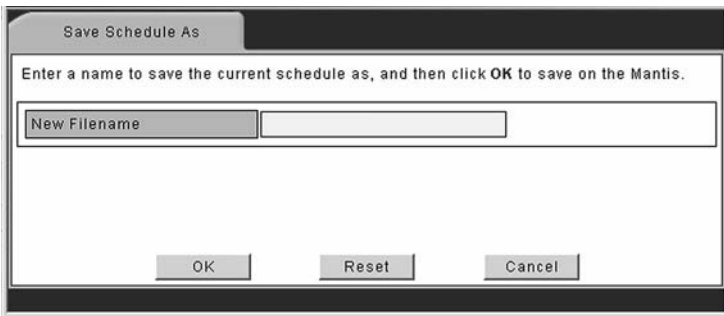

**Figure 13.** WebView Save Schedule Dialog Box

3. After entering the filename, click **OK** to save the modified schedule and to return to the Schedule Editor main page.  
If there is a check mark in the **Load schedule now** checkbox, found below the Mantis Media list, the modified schedule begins playing as soon as it is saved. The box is not checked, the schedule is saved, but playback does not start until the schedule is later selected for playback.

## Additional Saving and Loading Methods

Beyond the standard saving and loading methods directly to and from the Mantis, there are two local options available: Save Local and Load Local.

### Save Local

This option saves a copy of the schedule file currently being edited to the local work computer or network. This is feature permits transferring files to other Mantis players doing backing ups.

To perform a local save:

1. Click on the **Save Local** button at the bottom of the Schedule Editor screen.

An XML page appears displaying the file to be saved.

```
<?xml version='1.0' standalone='no' ?>
<DOCTYPE playlist PUBLIC "-//Virtual Circuits/DTD PLAYLIST 0.1/EN" "http://support.visualcircuits.com/dtd/schedule.dtd">
<schedule>
<global>
<default>Sample1.fsc</default>
</global>
<events>
<event playlist='Sample1.fsc' starttime='08:00' stoptime='12:00' interrupt='no' playonce='no' endcut=''>
<day name='sunday' />
<day name='monday' />
<day name='tuesday' />
</event>
<event playlist='Sample2.fsc' starttime='12:00' stoptime='16:00' interrupt='no' playonce='no' endcut=''>
<day name='sunday' />
<day name='monday' />
<day name='tuesday' />
</event>
<event playlist='demo.fsc' starttime='16:00' stoptime='23:59' interrupt='no' playonce='no' endcut=''>
<day name='sunday' />
<day name='monday' />
<day name='tuesday' />
</event>
</events>
</schedule>
```

**Figure 14.** Example WebView XML Schedule Page

2. Click on **Save** at the bottom of the XML page. A dialog box appears requesting information about where the file is to be saved.
3. Proceed saving the file to desired location.



### Add .fsc File Extension

When saving a schedule locally, it is necessary to add the schedule file extension **.fsc** to the filename.



## Load Local

The **Load Local** button provides the capability to load a schedule file from the local computer or network to the Mantis, rather than one already stored on board. This is useful when a schedule is stored on another computer or on removable media.

To perform a local load:

1. Click on the **Load Local** button at the bottom of the Schedule Editor screen. The following dialog box will appear:

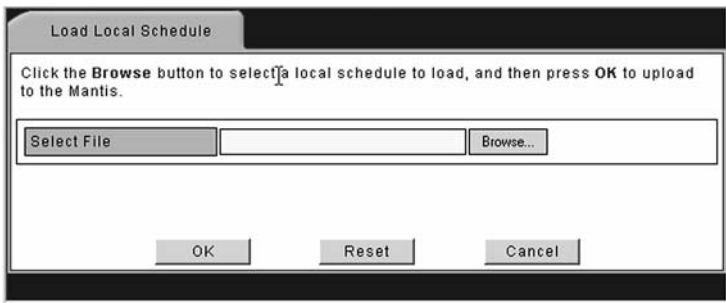

**Figure 15.** WebView Load Local Browse Dialog Box

2. Click the **Browse** button and locate the schedule file (.fsc) to be loaded.
3. Select the file and click **Open**.
4. The schedule loads to the Mantis and its filename appears in the Event field.
5. Click the **OK**.

The Schedule Editor main screen reappears with the schedule just loaded open and ready for editing.

## **Exiting the Schedule Editor**

At any point while working in the Schedule Editor you may exit by clicking on any of the menu navigation buttons on the left side of the screen. However, any unsaved changes made will be lost.

## Using the Player Control Panel

The Player Control provides basic video player controls: Play, Pause, and Stop and control the file currently playing: displayed on the output window. These controls work on a channel-by-channel basis. The controls Previous and Next provide for moving between playlists immediately before and after the list that is playing.

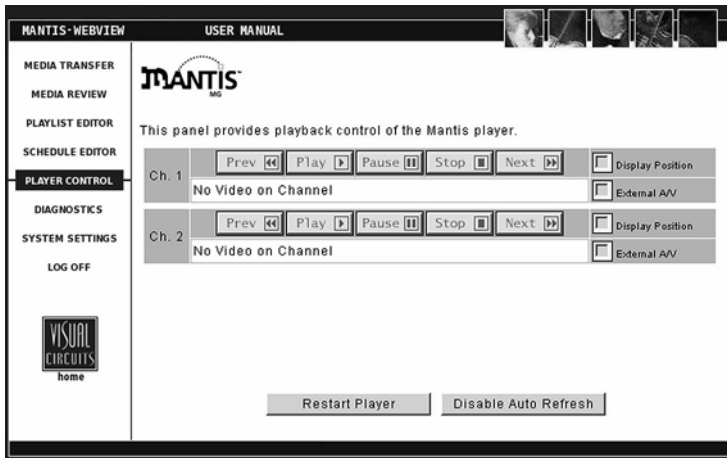

**Figure 16.** WebView Player Control Panel

In addition to using the standard player controls, the Display Position checkboxes permit displaying the position bar that shows the current playback position within the file.

## Diagnostics

The Diagnostics pages supply technical statistics about the Mantis. This is a tool to help the Visual Circuits technical support team work with you over the phone, in the event of problems.



The Diagnostics pages provide a snapshot of the system status at the time the pages were entered. The pages do not automatically update the information unless you click on the **Enable Auto Refresh** button.

The default Diagnostics pages contains three default types of information: General, Video, and Playback. When an optional feature is installed, a diagnostic page for that feature appears too.

By default, clicking on the **Diagnostics** displays the Mantis Diagnostics - General page. This page provides basic information about the Mantis and the media playing on it.

The screenshot shows the Mantis WebView interface. The top navigation bar includes 'MANTIS - WEBVIEW' and 'USER MANUAL'. The left sidebar contains menu items: MEDIA TRANSFER, MEDIA REVIEW, PLAYLIST EDITOR, SCHEDULE EDITOR, PLAYER CONTROL, **DIAGNOSTICS**, and SYSTEM SETTINGS. The main content area features the Mantis logo and a tabbed interface with 'general', 'video', 'playback', and 'logging' tabs. The 'general' tab is active, displaying a table of system statistics:

Player Version	3.30.2.28
Current loaded Schedule	None
Current loaded Playlist	saturn.fpl
Video loaded on Chan 1	05SATURN.MPG
Video loaded on Chan 2	05SATURN.MPG
Last CD/DVD Update	02/18/05 09:17
Last FTP Update	02/03/05 15:56
Last FTP Connect	02/03/05 15:54
Last NTP Sync	02/02/05 16:20
Watchdog Restarts	2
System Starts	5

At the bottom of the main content area is a 'Refresh Now' button. The Visual Circuits logo and 'home' link are located in the bottom left corner of the interface.

Figure 17. WebView Diagnostics - General Page

---

## Diagnostics - General

### **Player version**

Displays the version of the Mantis (incorporating both hardware and software).

### **Current loaded schedule**

Displays the file name of the currently loaded schedule (if applicable) on the system.

### **Current loaded playlist**

Displays the file name of the currently loaded playlist on the system.

### **Video loaded on Chan 1**

Displays the file name of the currently loaded video on this channel.

### **Video loaded on Chan 2**

Displays the file name of the currently loaded video on this channel.

### **Video loaded on Chan 3**

Displays the file name of the currently loaded video on this channel.

### **Video loaded on Chan 4**

Displays the file name of the currently loaded video on this channel.

### **Last CD/DVD Update**

Displays the date and time of the last automated CD/DVD update that employed an update packet, see *Automatic Updating* on page 109.

There are two other methods for updating from a CD/DVD, copying a media file and updating the software. Neither uses an update packet.

### **Last FTP Update**

Displays the date and time of the last FTP update.

### **Last FTP Connect**

Displays the date and time of the last FTP connect.

### **Watchdog Restarts**

Displays the number of times the Watchdog system has restarted the Mantis.

### **System Starts**

Displays the number of times the Mantis has been started.

## Diagnostics - Video

The screenshot shows the 'Diagnostics - Video' page in the WebView interface. The page has a sidebar on the left with navigation options: MEDIA TRANSFER, MEDIA REVIEW, PLAYLIST EDITOR, SCHEDULE EDITOR, PLAYER CONTROL, **DIAGNOSTICS**, SYSTEM SETTINGS, and LOG OFF. The main content area has a header with 'MANTIS MG' and a 'USER MANUAL' link. Below the header are tabs for 'general', 'video', 'playback', and 'logging'. The 'video' tab is active, displaying a table with the following data:

	1	2
Channel	1	2
Horiz Resolution	720	720
Vert Resolution	480	480
Video Bitrate	6056400	6056400
Audio Bitrate	256000	256000
Audio Frequency	48000	48000
Framerate	29.97	29.97
Current Frame	834	839
Timecode	2498494	1909908
File Type	MPEG2 program stream	MPEG2 program stream

At the bottom of the table area, there is a 'Refresh Now' button. The sidebar also features a 'VISUAL CIRCUITS home' logo.

Figure 18. WebView Diagnostics - Video Page

### Channel

Displays the number of the channel monitored.

### Horizontal Size

Width of image in pixels.

### Vertical Size

Height of image in pixels.

### Video Bitrate

Rate of video bits transfer (Kbps) at time of monitoring.

### Audio Bitrate

Rate of audio bits (Kbps) transfer at time of monitoring.

### Audio Frequency

Frequency of audio file.

**Frame Rate**

Number of individual frames or images displayed per second.

**Current Frame**

The frame ID number for frame currently displayed.

**Time Code**

Date-time stamp for frame identified in Current Frame.

**File Type**

Format of file being shown, i.e. MPEG1, MPEG2.

## Diagnostics - Playback

	1	2
Channel	1	2
Interrupts	0	0
AV Syncs	0	0
Last Sync	0	0
Video Data	0	0
Audio Data	0	0
Raw Data	4194304	4194304
Disk Underflow	1	0
Data Underflow	0	0

**Figure 19.** WebView Diagnostics - Playback Page

### Channel

The number of the channel monitored.

### Interrupts

Number of times the playback was interrupted during the play period.

### AV Syncs

Number of times the decoder has had to adjust the audio-video synchronization during the playback period.

### Last Sync

Timecode for the last time an AV synchronization occurred.

### Video Data

The amount of video data, in bytes, stored on the chip.

### Audio Data

The amount of audio data, in bytes, stored on the chip.



**Raw Data**

Total amount of data, in bytes, stored on the chip.

**Disk Underflow**

Data flow from the disk is not sufficient to keep the read buffers full.

This may be caused by:

- ❑ Disk data transfer rate has been exceeded
- ❑ File error is generating improper read errors
- ❑ If the problem occurs with a non-Mantis hard drive, there may be a bad or incorrect hard drive driver
- ❑ MPEG file encoded at too high a rate for application: see *Encoding Requirements and Recommendations* on page 15

**Data Underflow**

The flow of data to the decoder cache has slowed and the decoder may not be able to efficiently decode and transmit frames. Typically this can be ignored unless playback is effected.

- ❑ One symptom is that the decoder is not incrementing by 1 per file. If it is incrementing in the hundreds every few seconds there may be a problem with the MPEG file.
- ❑ The problem is how the MPEG file was originally encoded.

When the Diagnostic Log is enabled, the Mantis automatically records Data Underflow. Recording occurs at the end of each 24-hour period, (23:59).

## Diagnostics - Logging

Logging provides a record of what played on each channel: videos and their overlays, their starting dates/times, what percentage of playback completed successfully and how long they played.

At the top of the Logging page, from the **Select Logfile** drop down menu, select the log file to view.

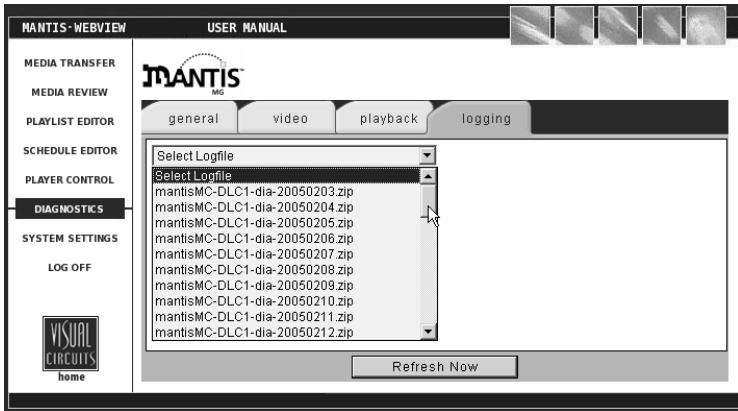

**Figure 20.** WebView Diagnostics - Logging Page

The two buttons located at the bottom of the Logging page, **Refresh** and **Auto Refresh**, permit setting the type of data refreshing desired. Auto Refresh instructs the system automatically to update the log file with current data at regular intervals.

Refer to *Uploading Log Files* on page 129 for information on setting up the Mantis logfiles feature.

Once in the logfile viewer, the video playback data lists with one video per line and sorts by playback time: using the Mantis internal 24-hour clock. Click on the <<Prev or Next>> links to move to the previous or next pages respectively. In addition, to view playback data for a certain time of day, enter either hours, minutes and/or seconds in the time boxes and then clicking the **Go** button.

### Time

Displays the time of day the event was logged based on the Mantis internal 24-hour clock.

**Chan**

Displays the Mantis output channel number.

**Filename**

Displays the filename of the video.

**Overlay**

Displays the filename of the graphic overlay that was associated with the video (if present).

**Duration**

Displays the total amount of time (HH: MM: SS) that a video played.

**%**

Displays the percentage played of the video.

## Diagnostic Logs

Diagnostic logs can be used to view a record of all media update procedures and system errors on a Mantis.

Information contained in the diagnostic log includes:

**FTP/DVD Updating data**

Tracks date, time of connection/disconnection, errors- yes/no, files, sizes, percent transferred and FTP permission errors.

**Storage Cleanup data**

Records what media files have been deleted by the automatic storage cleanup routine and includes filenames, sizes and dates.

**Missing Elements Log**

Records all missing media files referenced by an active playlist or schedule and includes date, time and file element.

**Error Summary data**

Records important user player diagnostic information and includes the number of system restarts, number of watchdog restarts, the player version, etc.

**Serial Commands**

Records most incoming and outgoing external control commands.

MANTIS-WEBVIEW USER MANUAL

MEDIA TRANSFER  
MEDIA REVIEW  
PLAYLIST EDITOR  
SCHEDULE EDITOR  
PLAYER CONTROL  
**DIAGNOSTICS**  
SYSTEM SETTINGS  
LOG OFF

general video playback logging

mantisMC-DLC1-run-20050224.zip (2704 - 2854) of 2854

<<Prev : : Go Next>>

time	ch	filename	overlay	duration	%
23:59:47	2	05SATURN.MPG		00:00:60	100
23:59:09	1	05SATURN.MPG		00:00:60	100
23:58:46	2	05SATURN.MPG		00:00:60	100
23:58:09	1	05SATURN.MPG		00:00:60	100
23:57:46	2	05SATURN.MPG		00:00:60	100
23:57:08	1	05SATURN.MPG		00:00:60	100
23:56:45	2	05SATURN.MPG		00:00:60	100
23:56:08	1	05SATURN.MPG		00:00:60	100
23:55:44	2	05SATURN.MPG		00:00:60	100
23:55:07	1	05SATURN.MPG		00:00:60	100
23:54:44	2	05SATURN.MPG		00:00:60	100

Refresh Now

**Figure 21.** WebView Diagnostics - Logging Page

In the Diagnostic logfile viewer, the data is listed with one diagnostic event per line and is sorted by playback time using the Mantis internal 24-hour clock. Use the <<Prev or Next>> links to move to the previous or next pages. To view diagnostic data for a specific time of day, entering either hours, minutes and/or seconds in the time boxes and click the **Go** button.

#### **Time**

Displays the time of day the event was logged based on Mantis's internal 24-hour clock.

#### **Source**

Displays the source of the diagnostic event (playback, multicast, system, etc.).

#### **Event**

Displays the diagnostic event.

## System Settings

The System Settings available in the WebView interface are basically the same as those found in the On-Screen Display menu. Within the System Settings menu, the following options are available:

### General Settings

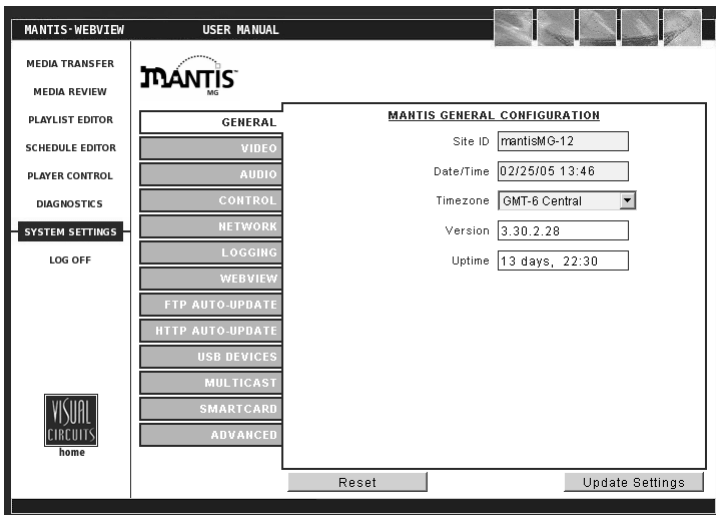

**Figure 22.** WebView System Settings-General



When a field is edited in any one of the following Settings Categories, the text for that category will turn red until you update the settings.

#### Site ID

The Site ID uniquely identifies the Mantis as it updates via FTP or CD/DVD-ROM. It is also used for Media Messenger software to enable automated management of the Mantis player's content, playlists and schedule updates.

#### Date/Time

Sets the Mantis internal clock for date and time.

**Time Zone**

Select the appropriate time zone in which the Mantis operates. The time zone is measured in hours and minutes plus or minus Greenwich Mean Time.

**Version**

The current version of the Mantis software.

**Uptime**

This value indicates how long the unit has been in operation since the last power cycle.

## Video Settings

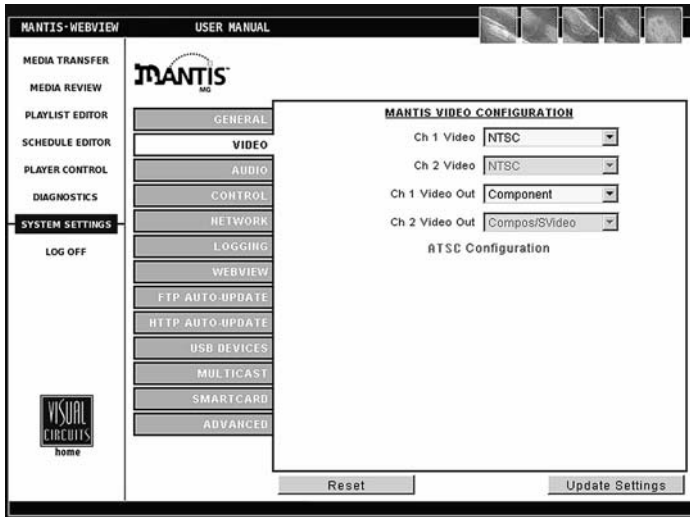

**Figure 23.** WebView System Settings-Video

### Video (formatting options)

The Video drop down menu lists NTSC and PAL video standards (regular and cropped) and a variety of display resolution options.

Select the video formatting option channel:

Video Standards	NTSC	PAL
	NTSC cropped	PAL cropped
<b>Scan Method</b>	<b>RGB Modes</b>	800 x 600 x 60
480p	640 x 480 x 50	1024 x 768 x 60
576p	800 x 600 x 50	1280 x 1024 x 60
720p	1024 x 768 x 50	1600 x 1200 x 60
720p50	1152 x 864 x 50	800 x 600 x 75
1080i	1280 x 960 x 50	1024 x 768 x 75
1080i50	1280 x 1024 x 50	1280 x 1024 x 75
	1600 x 1200 x 50	1600 x 1200 x 75
p = progressive i = interlaced	(width x height) pixels x (refresh rate) per sec.	



**NTSC and PAL Cropped**

.When HD video plays on a non-HD display, a black border appears around the image. Setting Video to a cropped option expands the image to fill the screen. In the process, top and bottom edges of the image is cut off and not displayed (cropping).

**Ch Video Output**

Selects the type of video output: Composite/S-video, RGB or Component. Composite, RGB, and S-Video signals can be used simultaneously.

**Video Card Configuration**

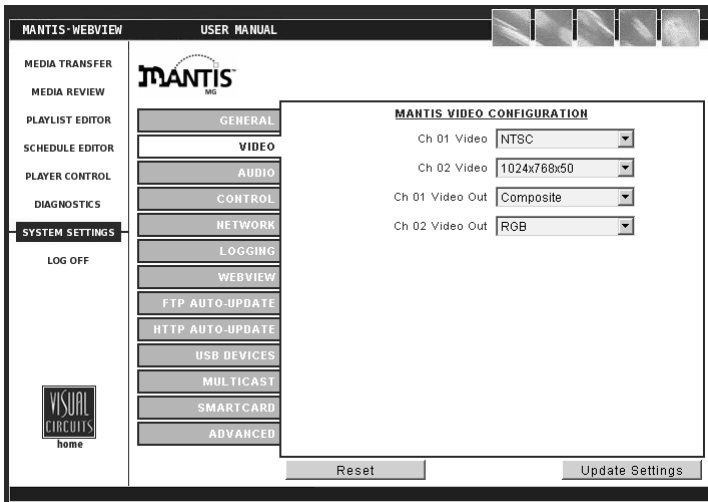

**Figure 24.** WebView System Settings - Video, Video Card Configuration



**Video Output Types and Supported Video Standards**

Composite and S-Video output only supports NTSC and PAL Video Standards.

Component supports all video standards.



## Audio Settings

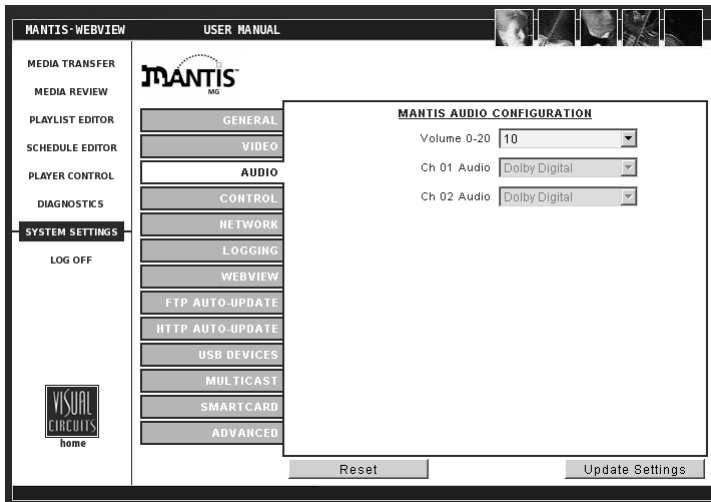

**Figure 25.** System Settings: Audio

### Volume

This setting adjusts the volume level for audio playback. The default volume setting is **10** on the 0-20 scale.



### WebView and External Control Command Audio Settings

Audio level setting scales are different for WebView and the External Control Commands. Unlike WebView's 0-20 scale, the external commands use a 0-255 level scale.

### Ch Audio

This option selects between Dolby Digital (stereo S/PDIF) and PCM analog output on a channel-by-channel basis. For MPEGs with standard layer-2 audio, setting channel audio to **Dolby Digital**, the default, turns on both the S/PDIF and analog stereo outputs. In this configuration, MPEGs containing AC3 audio play on the S/PDIF output only.

## Control Settings

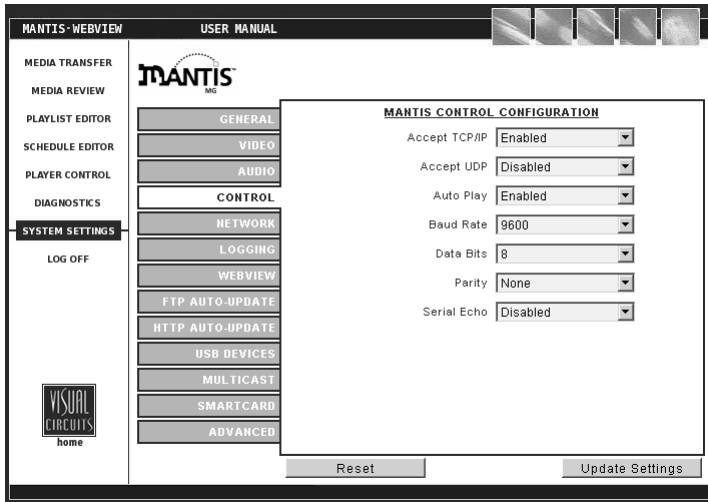

**Figure 26.** System Settings: Control

### Accept TCP/IP

In conjunction with RS232 serial communication, TCP/IP allows the user to remotely operate the Mantis by sending operation commands through a network or locally using an external PC or show controller, see *External Control Commands* on page 131).



For security reasons, “Accept TCP/IP” is factory defaulted to “No”. Be aware that if you decide to use this feature over a large network (namely the Internet), the potential for outside intervention (hacking) is greatly increased because there is literally no security (protection) on this port. Enabling this option will open port 2180.

### Accept UDP

Enable or disable the User Datagram Protocol. As with Accept TCP/IP caution is necessary in using this protocol.

**Auto Play**

This option enables and disables the auto play feature: default is **Off** (disabled).

When enabled, the Mantis at startup, automatically begins playing the most recently loaded playlist/schedule.

To initiate playbacks manually:

- Disable auto play
- Start playback using either the external (serial/tcp) commands, see , or go to **WebView > Player Control** and click on the **Play** button for the appropriate channel

**Baud Rate**

Select an identical value to your external controller. The following options are available: 1200, 4800, 9600, 38400 & 115200. It is recommended starting with a baud rate of 9600 for the hyper terminal connection.

**Data Bits**

Select an identical value to your external controller. The following options are available: 5, 6, 7, & 8.

**Parity**

Select an identical value to your external controller. The following options are available: None, Odd & Even.

**Serial Echo**

Enabling the serial echo permits the system to display manually input data entered through the serial interface.

## Network Settings

The screenshot displays the 'MANTIS NETWORK CONFIGURATION' web interface. On the left is a sidebar with a navigation menu including 'MEDIA TRANSFER', 'MEDIA REVIEW', 'PLAYLIST EDITOR', 'SCHEDULE EDITOR', 'PLAYER CONTROL', 'DIAGNOSTICS', 'SYSTEM SETTINGS' (highlighted), and 'LOG OFF'. Below the menu is the 'VISUAL CIRCUITS home' logo. The main content area features a 'MANTIS NETWORK CONFIGURATION' panel with the following settings:

- Hostname:
- Mode:  (dropdown menu)
- IP Address:
- Netmask:
- Gateway:
- FTP Proxy Type:  (dropdown menu)
- FTP Proxy IP:
- FTP Proxy Port:
- HTTP Proxy Type:  (dropdown menu)
- HTTP Proxy IP:
- HTTP Proxy Port:
- NTP Client:
- SNMP Server:
- SNMP Traps:

At the bottom of the configuration panel are two buttons: 'Reset' and 'Update Settings'.

**Figure 27.** System Settings: Network Configuration

### Host Name

Choose a unique name that identifies each Mantis unit on the network.

### Mode

**DHCP** (Dynamic Host Configuration Protocol) - A TCP/IP service protocol that offers dynamic leased configuration of host IP addresses and distributes other configuration parameters to eligible network clients. DHCP provides safe, reliable, and simple TCP/IP network configuration, prevents address conflicts, and helps conserve the use of client IP addresses on the network. DHCP uses a client/server model where the DHCP server maintains centralized management of IP addresses that are used on the network. DHCP-supporting clients can then request and obtain use of an IP address from a DHCP server as part of their network start up process. *See your Network Administrator for further information.*

**STATIC** - A fixed IP address, typically used in a local area network (LAN). Requires fixed IP, subnet mask, and default gateway addresses. For all other connections, type the IP address. *See your Network Administrator for further information.*

**IP Address**

A 32-bit address used to identify a node on an IP network. Each node on the IP network must be assigned a unique IP address, which is made up of a network identifier and a host identifier. This address is typically represented in dotted-decimal notation, with the decimal value of each octet separated by a period, for example, 192.168.7.27.

You can configure the IP address statically, or dynamically through DHCP. *See your Network Administrator for further information.*

**Netmask**

Most TCP/IPT networks use subnets in order to effectively manage routed IP addresses. For the range that you specified in From and To, Windows 2000 calculates the closest matching subnet. The range of addresses in the closest matching subnet may exceed the range that you specified. Unless the addresses specified in From and To are subnet boundaries, the range based on the calculated subnet will be larger than the range that you specified. To avoid this, specify a range that falls on subnet boundaries. For example, if you are using the 10.0.0.0 private network ID for your intranet, a range that falls on subnet boundaries is 10.0.1.168 to 10.0.1.175. Or, if you are using the 192.168.0.0 private network ID for your intranet, a range that falls on subnet boundaries is 192.168.1.0 to 192.168.1.255. *See your Network Administrator for further information.*

**Gateway**

A service that allows the Mantis to connect to other servers. Creating a gateway also allows client computers running only Microsoft client software to access server resources through the gateway. *See your Network Administrator for further information.*

**FTP Proxy Type**

Allows you to select the type of proxy (None, Socks4, Socks5, USER usr@hst p, USER usr@hst:p, SITE usr@hst p, SITE usr@hst:p, NetCache or NAT Firewall).

Note: The NAT Firewall setting will put the FTP client in passive mode.

**FTP Proxy Address**

The IP address of the proxy server, if used.

**FTP Proxy Port**

The port assigned for FTP proxy use.

### HTTP Proxy Type

Allows you to select the type of proxy (None, Socks4, Socks5, USER usr@hst p, USER usr@hst:p, SITE usr@hst p, SITE usr@hst:p, NetCache or NAT Firewall).

Note: The NAT Firewall setting will put the FTP client in passive mode.

### HTTP Proxy Address

IP address of HTTP proxy server.

### HTTP Proxy Port

Address of port.

The screenshot shows a configuration window for the NTP Client. At the top, there is a label 'HTTP Proxy Port' followed by an empty text input field. Below this is a section titled 'NTP Client' enclosed in a box. Inside this box, there are five settings: 'Enable NTP' is a dropdown menu set to 'Disabled'; 'NTP Server' is a text input field containing '192.168.0.130'; 'Dialup Connect' is a dropdown menu set to 'Disabled'; 'Dialup Retries' is an empty text input field; and 'NTP Sync Interval' is a text input field containing '86400'. Below the 'NTP Client' box, there are two more labels: 'SNMP Server' and 'SNMP Traps', both without associated input fields.

**Figure 28.** System Settings: Network NTP Client Configuration,

### Enable NTP (Network Time Protocol)

NTP must be enabled and set. At regular intervals, the NTP synchronizes the internal clocks of all systems on a local network.

### NTP Server

The IP address of the server providing NTP and that the Mantis must time-sync with.

### Dialup Connect

Default for dialup is Disabled.

### Dialup Retries

The number of attempts to connect to the NTP server that the Mantis may try.

### NTP Sync Interval

The NTP synchronization interval is set in seconds, thus 300 equals 5 minutes.

NTP Client

SNMP Server

Enable SNMP

Engine ID

SNMP Network

SNMP Netmask

Community

Security Name

Auth Passphrase ?

Priv Passphrase ?

SNMP Traps

**Figure 29.** System Settings: Network SNMP Server Configuration

### Enable SNMP (Simple Network Management Protocol)

The SNMP feature permits monitoring the Mantis via the network, as well as retrieving and changing its settings. This is done through the use of the Mantis MIB file.

### Engine ID

A unique ID number, similar to siteID, assigned to the Mantis by a SNMP trap daemon or server.

### SNMP Network

Designates the IP address of the system(s) that are to monitor and control the Mantis. Use standard dotted-decimal notation for all IP settings. To allow an individual machine to control the Mantis, set to a specific IP address, for example 192.168.0.100. To allow a group of machines to control the Mantis, set the IP to a range, 192.168.0.0).

### SNMP Netmask

Designates the Netmask information for the system(s) that are to monitor and control the Mantis. For an individual controller, as described above, set the netmask to 255.255.255.255. For multiple controllers, as in the range example above, use 255.255.255.0.

### Community

The SNMP Community name defines the relationship between an SNMP server system, the Mantis, and the client systems. This acts as a password to control the clients access to the Mantis.

### Security Name

This is a SNMPv3 feature. Use this to set the security name for the authentication and encryption for SNMP transmissions.

### Auth Passphrase

An SNMPv3 feature, it provides authentication but no encryption on SNMP information.

### Priv Passphrase

An SNMPv3 feature, it provides authentication and encryption on SNMP information.

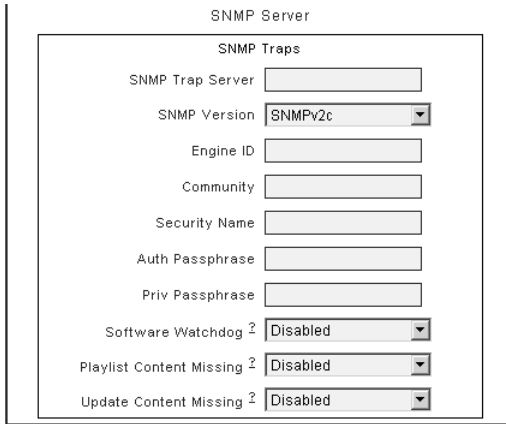

The image shows a screenshot of the 'SNMP Server' configuration window. The window has a title bar 'SNMP Server' and a subtitle 'SNMP Traps'. Below the subtitle, there are several configuration fields:

- SNMP Trap Server: A text input field.
- SNMP Version: A dropdown menu with 'SNMPv2c' selected.
- Engine ID: A text input field.
- Community: A text input field.
- Security Name: A text input field.
- Auth Passphrase: A text input field.
- Priv Passphrase: A text input field.
- Software Watchdog: A dropdown menu with 'Disabled' selected.
- Playlist Content Missing: A dropdown menu with 'Disabled' selected.
- Update Content Missing: A dropdown menu with 'Disabled' selected.

**Figure 30.** System Settings: Network SNMP Traps Configuration

Configuring the SNMP traps controls allows the Mantis to send diagnostic messages to a SNMP trap daemon operating on a client or a SNMP trap server. Mantis does not require a trap server to use SNMP trapping, see Engine ID for details. The traps that may be enabled are

- ❑ Software watchdog  
Mantis sends the ID of the channel that had the watchdog event
- ❑ Playlist content missing  
Mantis sends the file
- ❑ Update content missing  
Only available for Multicast

### SNMP Trap Server

The IP address of the target SNMP client or SNMP trap server.



---

**SNMP Version**

The currently installed version of SNMP.

**Engine ID**

This is a unique number generated by the SNMP trap daemon when initially started and displayed in the SNMP Server field, **Engine ID**, see page 81.

**Sending Mantis SNMP Traps**

It is necessary for the SNMP Traps - Engine ID field to contain a unique ID number that the SNMP trap daemon recognizes as belonging to a specific Mantis. The engine ID generated by the daemon can be used or a network unique number can be assigned by the user.

**Community**

Acts as a password to control the clients access to the Mantis, see preceding page for description.

**Security Name**

Use this to set the security name for the authentication and encryption for SNMP transmissions.

**Auth Passphrase**

It provides authentication but no encryption on SNMP information.

**Priv Passphrase**

It provides authentication and encryption on SNMP information.

**Software Watchdog ?**

Enabling permits the Mantis to send watchdog events for all channels.

**Playlist Content Missing ?**

Enabling missing content allows Mantis to send message files with details of missing content.

**Update Content Missing ?**

Available only for optional Multicast feature. Enabling sends file that lists missing update content.

## Logging Settings

The screenshot shows the 'MANTIS MG' interface with the 'logging' tab selected. The table below displays the following data:

time	ch	filename	overlay	duration	%
23:59:47	2	05SATURN.MPG		00:00:60	100
23:59:09	1	05SATURN.MPG		00:00:60	100
23:58:46	2	05SATURN.MPG		00:00:60	100
23:58:09	1	05SATURN.MPG		00:00:60	100
23:57:46	2	05SATURN.MPG		00:00:60	100
23:57:08	1	05SATURN.MPG		00:00:60	100
23:56:45	2	05SATURN.MPG		00:00:60	100
23:56:08	1	05SATURN.MPG		00:00:60	100
23:55:44	2	05SATURN.MPG		00:00:60	100
23:55:07	1	05SATURN.MPG		00:00:60	100
23:54:44	2	05SATURN.MPG		00:00:60	100

**Figure 31.** System Settings: Logging

### Run Log

Turns **On** or **Off** the Run log which creates a record of which videos played (with which graphic overlays, if applicable), starting at what dates/times, playing back what percentage of the video and for how long.

### Diagnostic Log

Turns **On** or **Off** the Diagnostic log which makes a record of all media update transactions and any system errors on a Mantis. For more information about the Diagnostic Log, *Diagnostics - Logging* on page 68.

## Log Format

Sets the output format of the run log file to either CSV or XML.

Sample from a CSV format run log:

```
12-07-02 20:30:07,1,05saturn.mpg,3_ser220.BMP,1,00:01:01,100
```

Sample from a XML format run log:

```
<mpeg datetime="12-07-02 20:32:57" chan="1"
filename="05saturn.mpg" overlay="3 ser220.BMP" loop="1"
duration="00:01:01" percent="100" 7>
```

The format of the diagnostic log is in a simple “time - event” per line format.

## Log Default Playlist

Permits whether or not the default playlist playback is included in the playback log file data. Choosing **Yes** includes the default playlist in the playback data.

If you are not using the scheduling feature (single playlist mode), note that the playlist will not be logged.

## Max Log MBs

Sets the maximum size, MB, that a log file may become. The default value is 10 MB. Keep this value relatively small if maintaining a large amount of free space for videos and graphic overlays.

If there is not enough reserved space, the Mantis deletes the oldest residing logs in order to make room for the new ones.

When the log files exceed the maximum amount of defined storage space, an automatic cleanup process will delete the oldest file as required to contain the total log file space under the set limits. In addition, files are deleted after they are transferred to the FTP server or downloaded from the Mantis player.

## Upload Logs

Permits the uploading of log files to the *logfile*s directory on an FTP server.

Once the log files are uploaded to the FTP server, they may be downloaded to a range of storage options, such as a database.



After log files have been successfully uploaded to your FTP server, they will be deleted from the Mantis.

## WebView Settings

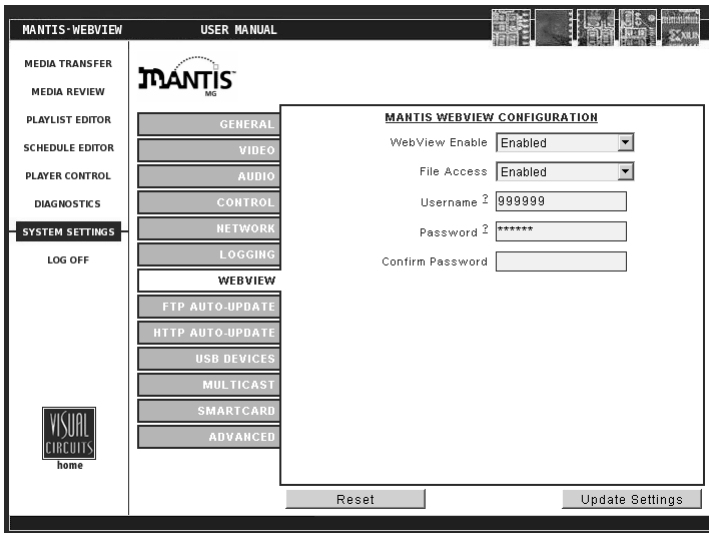

**Figure 32.** System Settings: WebView

### WebView Enable

This feature gives the user access to the Mantis over a network using a conventional web browser (see *WebView™* on page 29).

### File Access

Permits accessing the Mantis directly with an FTP client.

### Username

Enter at least 6 (but no more than 15) alphanumeric characters here. This field is case sensitive.



The user name and password are used for *both* WebView and the FTP server.

### Password

Enter at least 6 (but no more than 15) alphanumeric characters. This field is case sensitive.



It is strongly recommended to change the user name and password from their original default values for system security

## FTP Auto-Update Settings

The screenshot shows the 'MANTIS-WEBSITE' interface with a sidebar on the left containing menu items: MEDIA TRANSFER, MEDIA REVIEW, PLAYLIST EDITOR, SCHEDULE EDITOR, PLAYER CONTROL, DIAGNOSTICS, SYSTEM SETTINGS (highlighted), and LOG OFF. Below these is a 'VISUAL CIRCUITS home' logo. The main content area has a 'USER MANUAL' link and a 'MANTIS' logo. A central panel titled 'MANTIS FTP AUTO-UPDATE CONFIGURATION' contains the following settings:

- FTP IP Address:
- FTP Port:
- Username:
- Password:
- Confirm Password:
- Directory:
- Update Interval:  (dropdown)
- Fixed Upd Time:  (dropdown)
- Delete Content:  (dropdown)
- Dialup Connect:  (dropdown)
- Dialup Retries:

At the bottom of the configuration panel are 'Reset' and 'Update Settings' buttons. A 'FTP Update Now' button is also present within the configuration area.

**Figure 33.** System Settings: FTP Auto-Update

### FTP IP Address

Enter the IP address of the FTP server.

### FTP Port

Enter the port for the FTP server. If left blank during an update, this field will continue to show a blank value and FTP will use port 21. Once a value is entered and saved, the new value appears in this field.

### Username

Enter the FTP server username. Leave this blank if no username is present.

### Password

Enter the FTP server password. Leave this blank if no user password is present.

### Directory

Leave this blank. Use the home directory of the FTP account to place media, playlists, schedules and/or updates folders. In the case where multiple Mantis with different content are used, directories may be set up for each Mantis.

### Update Interval

Permits scheduling FTP updates at regular intervals or at a fixed time. The default is one hour.

**Fixed Update Time**

Allows the setting of a fixed time, on an hourly basis, for an FTP update, for example 14:00. To activate this field, first set the Update Interval to **Use Fixed Time**.

**Delete Content****Use Delete Content with Caution**

This process removes, from the FTP server, all files within the accessed directory, except for those used in the most recent content update.

Permits a Mantis player to instruct the FTP server to delete content files from the server. After an update, if Delete Content is enabled, the FTP server deletes all of the content files in the accessed directory, except for the one used in the most recent update.

For example, there are two Mantis players, Mantis1 and Mantis2, on the network and they each have their own update files, Mantis1.tar and Mantis2.tar, on the FTP server. If Mantis1 has Delete Content enabled and performs an update, the server removes Mantis2.tar and only Mantis1.tar remains. When Mantis2 attempts to update, its file is missing and the update fails.

If it is necessary to update multiple players and it is necessary to use the Delete Content function, there are two methods to consider:

- a. Because Delete Content does not touch files in other directories, create a directory on the FTP server for Mantis2 and place its update file Mantis2.tar in it.
- b. If both players use the same update content, name the content update *firefly.tar*. This is the default update filename that a player searches for when it can not find an update targeted specifically to it. For details about FTP updating see, *FTP Updating* on page 113.

**Dialup Connect**

Dialup number for network where the FTP server is located.

**Dialup Retries**

Number of attempts that the Mantis may make before it stops trying to dialup the FTP server.

**FTP Update Now**

Pressing this button initiates an immediate download of any new media, playlists, schedules and or updates.

## HTTP Auto-Update Settings

The screenshot shows the Mantis Webview system settings interface. On the left is a navigation menu with categories like MEDIA TRANSFER, PLAYLIST EDITOR, SCHEDULE EDITOR, PLAYER CONTROL, DIAGNOSTICS, and SYSTEM SETTINGS. The SYSTEM SETTINGS menu is expanded to show options like LOG OFF, HTTP AUTO-UPDATE, and others. The main content area displays the 'MANTIS HTTP AUTO-UPDATE CONFIGURATION' window. This window contains several input fields: 'HTTP Address', 'HTTP Port', and 'HTTP Directory' are text boxes; 'Update Interval' is a dropdown menu currently set to 'Disabled'; 'Fixed Upd Time' is a dropdown menu currently set to '00:00'. There is an 'HTTP Update Now' button. At the bottom of the configuration window are 'Reset' and 'Update Settings' buttons. The interface also features the Mantis logo and a 'VISUAL CIRCUITS home' logo.

**Figure 34.** System Settings: HTTP Auto Update

### HTTP Address

Enter the HTTP server IP Address here.

### HTTP Port

Allows entering a specific port for the HTTP server. If left blank during an update, this field will continue to show a blank value, and HTTP will use port 80. Once you enter a value for the port and save, your new value will populate this field.

### HTTP Directory

Leave this blank. Use the home directory of the HTTP account to place media, playlists, schedules and/or updates folders. In the case where multiple Mantis with different content are used, directories may be set up for each Mantis.

### Update Interval

Permits scheduling HTTP updates at regular intervals or at a fixed time.

### Fixed Update Time

Allows setting a fixed time, on the hour, for an HTTP update, i.e. 14:00. To activate this field, first set the Update Interval to **Use Fixed Time**.

### Update Now Button

Pressing this button initiates an immediate download of any new media, playlists, schedules and or updates.

# USB Devices

## Dialup Client

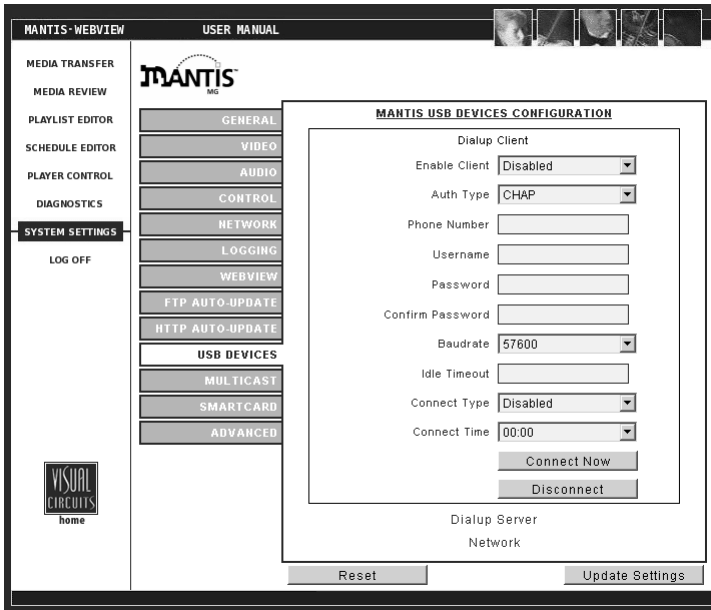

**Figure 35.** System Settings: USB Devices Configuration - Dialup Client

The Mantis may be configured as either a USB client or server and it may be set to dial on demand and send data if required.



**Setting Mantis IP Address when Accessing Network via USB**

When using the USB port to access a network, acquire an IP address, it is necessary to go to the USB Network window to set this value. The System Settings, Network window settings are not applied.

Likewise, to check the assigned IP address, it is necessary to go to the USB Network window. The System Settings, Network window does not display the correct IP address.

**Enable Client**

Enable if dialup is required.



**Auth Type**

Select the type of authentication protocol used.

**Phone Number**

Number used for dialup.

**Username**

Enter the USB server username. Leave blank if a username is not used.

**Password and Confirm Password**

Enter the USB server password. Leave blank if a password is not used.

**Baud Rate**

Select the transfer rate (bps) to use while using the dialup connection.

**Idle Timeout**

Set time limit for how long the connection may be idle before timing out.

**Connect Type**

Permits setting method for connecting to USB network. Set to **Use Fixed Time** if using an automated connection at a standard time.

**Connect Time**

Allows setting a fixed time, on the hour, for connecting to the USB network, i.e. 14:00. To activate this field, first set the Connect Type field to **Use Fixed Time**.

**Connect Now**

Pressing this button initiates an immediate dialup and connection to the USB server.

**Disconnect**

Pressing this button initiates the disconnect from the server.

---

**MANTIS USB DEVICES CONFIGURATION**

Dialup Client

Dialup Server

Enable Server

Auth Type

Server Address

Client Address

Username

Password

Confirm Password

Network

**Figure 36.** System Settings: USB Devices Configuration - Dialup Server

**Enable Server**

Enable if Mantis is to perform as the USB server.

**Auth Type**

Select the type of authentication protocol used.

**Server Address**

IP address of USB dialup server if Mantis is client.

**Client Address**

IP address of client if Mantis is server.

**Username**

Username and password for accessing USB server.

**Password and Confirm Password**

User's password for accessing USB server.

---

**MANTIS USB DEVICES CONFIGURATION**

Dialup Client  
Dialup Server

Network

Mode

IP Address

Netmask

Gateway

**Figure 37.** System Settings: USB Devices Configuration - Network

**Node**

Enter node ID for the USB server.

**IP Address**

Enter the USB server's IP Address.

**Netmask**

Enter the USB server's netmask

**Gateway**

If a gateway is used, enter IP address for it.

## Multicast Settings

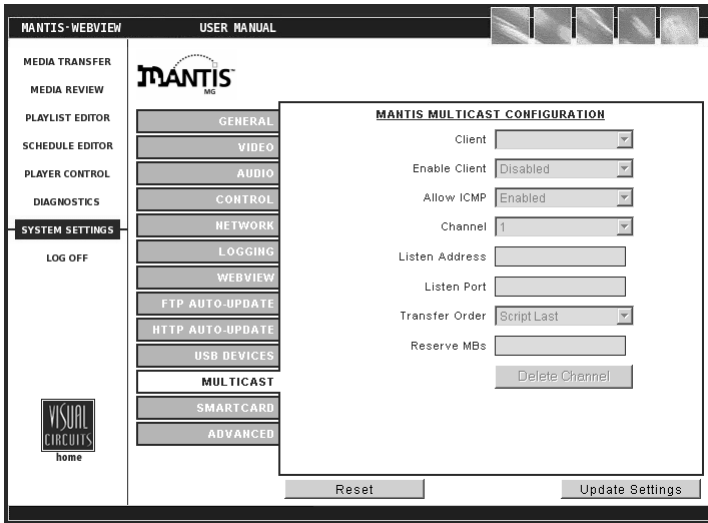

**Figure 38.** System Settings: Multicast

Multicast is an optional feature.

### Client

Select the broadcast protocol to be used.

### Client Enable

Enable or disable the multicast client.



### Activating Changes to Multicast Settings

To apply changes made to Multicast settings, it is necessary to toggle the Client Enable setting from Disabled to Enabled.

For more information on multicasting, see *Multicast Updating* on page 117.

### Allow ICMP

Internet Control Message Protocol - Set to allow ICMP if using a gateway.

### Channel

Like presets, you can assign a Channel number for each “Listen” configuration. This allows you to easily recall up to 99 Channels of Listen Address & Port combinations.

---

**Listen Address**

The IP address that the multicast client listens to. The value must be a Class D multicast address, which typically starts with 224.xxx.xxx.xxx. Because some addresses may be reserved (see below), consult with the Network Administrator for assistance.



- 224.0.0.0/24 is reserved by RFC.
- 224.0.1.0/24 is used by specific applications (NTP).

**Listen Port**

The port address that the multicast client will listen on.

**Transfer Order**

Permits setting the order in which the items are transferred: package mode or script last mode.



Multicasting is an optional feature enabled by a software upgrade. If the Mantis does not have the Multicasting feature (menu items are “grayed out”) and your application requires it, contact a Visual Circuits representative at 1-800-250-5533.

**Reserve MBs**

Permits allocating a fixed amount of the Mantis internal storage space for receiving a multicast update. To determine this value, estimate the largest multicast update likely to be received, i.e. 1000 MBs. Next, double that amount to allow room for both the compressed archive and the extraction process, i.e.  $1000 \text{ MBs} \times 2 = 2000 \text{ MBs}$ .

**Delete Channel**

Defaults Listen fields to empty for the channel deleted.

## Smart Card Settings

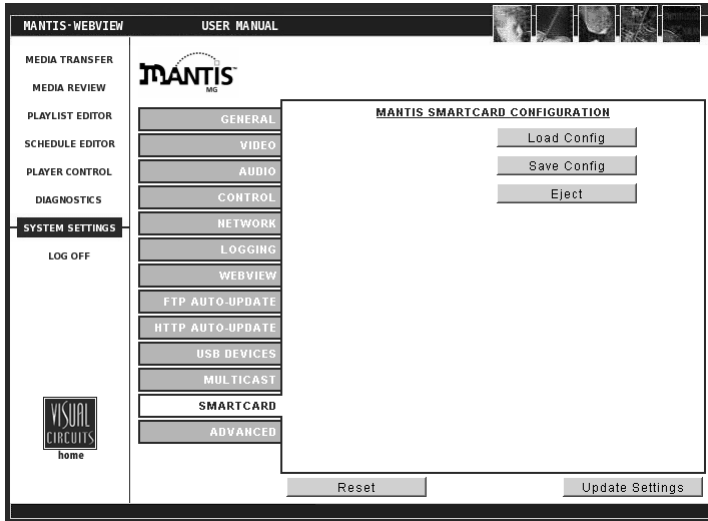

Figure 39. System Settings: Smart Card

### Load Config

Permits the loading of a configuration in to the Mantis from an inserted Smart Card. Once loaded, the Mantis detects the new system settings and changes any necessary system settings according to the configuration stored on the Smart Card.

### Save Config

Permits saving the current Mantis configuration with all its system settings to the Smart Card.

### Eject Smart Card

Ejects an inserted Smart Card from the Mantis' internal Smart Card reader. The Smart Card can also be ejected using the front panel controls, see *Eject the Smart Card* on page 27 for details).

## Advanced Settings

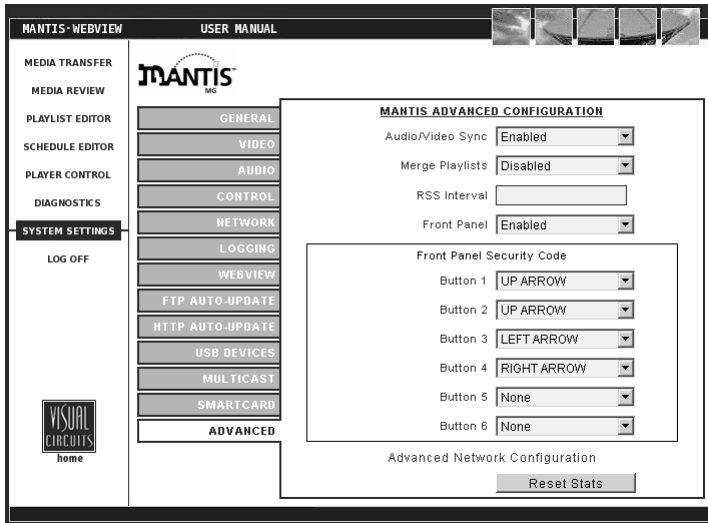

**Figure 40.** System Settings: Advanced Configuration

### Audio/Video Sync

Permits enabling or disabling audio/video synchronization.

Turning the audio to video synchronization or “lip sync” off, sometimes eliminates stuttering video playback. This may however result in poor audio to video synchronization. Consult with a Visual Circuits representative if the problem continues.

### Merge Playlists

The behavior of the Merge Playlists feature depends on which mode the Mantis is operating in, Single Playlist vs. Schedule.

When in Single Playlist mode the existing playlist is ignored, i.e., the incoming playlist is merged with the current playing one regardless of the playlist filename.

If working in Schedule Mode and a new playlist has the same filename as a playlist already on the system, any empty channels on the new playlist utilize the channels from the original playlist.

### RSS Interval

Not supported in the Mantis at this time.

## Front Panel Security Code

The Mantis security code consists of pressing from 2 to 6 of the front panel buttons in a predetermined sequence.



### Warning: Security Code Conventions

The Front Panel Security Code must conform to the following rules:

- **Button 1** must be used and **Can Not Be Blank**.
- Blank Buttons can not be used in the code: all buttons used must contain a value.

## Reset Stats

Allows resetting the basic System Statistics, the number of Watchdog Restarts and System Starts, to zero. To view these statistics, go to *Diagnostics - General* on page 63.

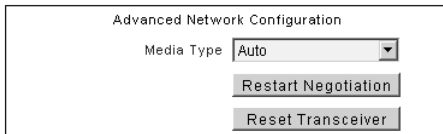

**Figure 41.** System Settings: Advanced Configuration - Network

## Media Type

If the Mantis update procedure appears to be lagging, use this control to set the Mantis to a specific network/media content combination. The observed increase in update performance depends on actual network configuration.

## Restart Negotiator

Click to starts Mantis auto negotiating media type with the other end of the line.

## Reset Transceiver

Click to restart the transceiver and signalling on the physical level.



## Overview

Use Mantis media players to create private broadcast networks for advertising, education, instruction, and entertainment. Mantis players are fully functional network nodes with integrated FTP capabilities that permit widespread deployment and provide unattended playback operations.

Networking allows the management and control of the media players from a central location.

To manage and control a Mantis network, use the Visual Circuits Media Messenger™ software. Media Messenger is a suite of tools for the creation, distribution, and management of presentation layouts, playlists, and playback schedules. In addition, it provides networking tools for the assembly of media player virtual networks and the distribution and management of media content files: video and graphics.

For more information about Media Messenger, go to page 101.

## Getting Started

The following questions should be considered when establishing a network:

- ❑ Number of Mantis media players and update method?
- ❑ Bandwidth of communication to each media player?
- ❑ Playback programming: scripted/show controller/combined?
- ❑ Creation of MPEG2 videos: pre-production, post-production?
- ❑ Service and maintenance of deployed systems?
- ❑ Installation of network infrastructure: displays, cabling, control devices, etc.?

# Media Messenger™ Software

Visual Circuits Media Messenger™ software (sold separately) combined with Mantis media players creates a simple, yet powerful, end-to-end solution for the distribution and utilization of high-quality digital media.

## Product Features

- ❑ Windows XP/2000 compatible
- ❑ Network Manager - for grouping and organizing Mantis players graphically
- ❑ Playlist Editor - for generating customized playlists of videos and graphic overlays
- ❑ Schedule Editor - for scheduling target programming by date and/or time
- ❑ Media Messenger Publisher - for publishing unique content centrally via FTP
- ❑ Media Messenger CD/DVD Creator - for creating Media Update Discs for global or site-specific content distribution

## Benefits

- ❑ Provides centralized management of a network of Mantis media players
- ❑ Creates diverse programming by integrating video and graphics into playlists.
- ❑ Facilitates easy playback and updating of programming based on date, time, region or sub-grouping of locations
- ❑ Delivers content rapidly over the internet using FTP
- ❑ Manages content centrally while allowing for local updating
- ❑ Eliminates system intervention at local venue level
- ❑ Publishes content via CD/DVD, minimizing networking and distribution expenses
- ❑ Supports scalable expansion

To learn more about Media Messenger, contact a Visual Circuits representative at 1-800-250-5533 or visit [www.visualcircuits.com](http://www.visualcircuits.com).



# UPDATING VIDEO PLAYBACK

---

Mantis media players offer a variety of methods for updating video content. These updating processes include both automatic and manual procedures.

## **Automatic Updating**

### **Media Update discs** (page 109)

These discs are for updating local systems: made with standard CD/DVDs, they are inexpensive and easy to use. Create update discs with Visual Circuits Media Messenger software. Once the videos are copied to the Mantis, playback begins automatically.

### **Drop & Go discs** (page 111)

Drop & Go Discs are for updating local systems and are made with standard CD/DVDs. They are inexpensive and easy to use. Create Drop & Go discs using common CD/DVD writing programs, no special applications are required. Once videos are copied to the Mantis, playback begins automatically.

### **FTP, HTTP & Multicast Auto-Update** (page 113)

Use the network to regularly update Mantis players with any new media, playlists, schedules and system updates, via FTP, HTTP, or Multicast.

## **Manual Updating**

### **WebView** (page 121)

Use this web-based interface to transfer media from a local computer or network to the Mantis player. WebView also offers capability for creating, editing or deleting playlists and schedules on the Mantis.

### **Standard CD's/DVD's** (page 121)

Use standard CD/DVD discs containing MPEG and graphic overlay files to update the media on local systems.

### **Direct File Access** (page 122)

Use an FTP client to access the Mantis directly.

**Table 1:** Automatic and Manual Video Content Updating

## Overview of the Update Process

The following steps are typical of the Mantis updating process. The Mantis:

1. Identifies the CD/DVD as either a valid content or system software update disc:
  - a. If a valid content update disc proceed, see below,
  - b. If valid software update disc proceed to page 107,
  - c. If not a valid update disc the Mantis ignores it and does nothing.
2. Determines best method to process the update content, see below.
3. Uses the updating routine order to determine what type of file it must process, see page 106.
4. Applies the playlist parsing routine to load the updated playlist and the necessary media files, see page 106.
5. Runs the storage cleanup routine to insure that there is adequate space on the Mantis for the new files, see page 107.
6. Creates a content log at the end of every 24 hour cycle, see page 108.

## 2 Content Update Processing

When the Mantis detects a valid content update CD/DVD, it initiates a routine to decide how best to process it.

1. The Mantis checks to see if there is an update packet specifically targeted for it. This is done by determining if the update packet filename matches the site ID of the Mantis. If, for example, the site ID of the Mantis is set to *location1*, the Mantis would look for a file by the name of *location1.tar*. When the Mantis finds the file, it copies the file and moves on to the playlist parsing routine, see next page.
2. If the Mantis does not detect an update packet with a name matching the site ID, it searches for a generic package file with the filename of *firefly.tar*.
3. If this package is found, the Mantis copies it and moves on to the parsing routine, see the next page.

Filename	Definition
<i>siteid.*</i>	a specific Mantis player
<i>firefly.*</i>	any Mantis player

**Table 2:** Filenames and Definitions

Alternatively, instead of a package file, the Mantis can use either a playlist (.fpl) or schedule (.fsc) file.

File Extension	Definition
.tar	update packet contains schedule/playlist files
.fsc	single schedule file (playlist must already reside on Mantis player)
.fpl	single playlist file

**Table 3:** File Extensions and Definitions

### 3 Updating Routine Order

The Mantis system looks for an update file following a specific order. It proceeds sequentially through the order until it finds a matching file and then proceeds to the playlist parsing routine, below.

1. *siteid.tar*
2. *firefly.tar*
3. *siteid.fpl*
4. *firefly.fpl*
5. *siteid.fsc*
6. *firefly.fsc*
7. \*.tar
8. \*.fpl

Use of the filename convention described earlier, permits the creation of a single disc that can work for multiple Mantis players. Using individual site IDs in the filenames, it is possible to have all of the media files and update packets multiple Mantis players.

### 4 Playlist Parsing Routine

When the Mantis copies a new playlist, it analyzes the list to determine which MPEG video files it needs. The Mantis then checks its own storage to determine if any of these videos are already present. Any files that are not present already present and up to date, are copied from the CD/DVD.

For a preexisting file, the Mantis compares its file size against a file with the same name located on the CD/DVD. Only if the file on the disc has a different file size, does the Mantis copy it and overwrite the pre-existing file.



#### **File Size Criteria**

File size is a more reliable indicator than creation date or other conventional means and is used to determine if two files are the same. This is because it is extremely unlikely that two MPEG files with similar but not identical (i.e. edited) content would be exactly the same size.

Once all of the required video files are copied from the disc, the Mantis begins playing the new playlist or schedule.



## 5 Mantis Storage Cleanup Routine

When the Mantis copies files to its internal storage, it compares the total amount of space required to store the files against the space that is available. If the Mantis determines that there is not enough space, it runs a cleanup routine to make room by removing the oldest, unused MPEG files.

To do this, the Mantis refers to the Content Log, see *Content Log* on page 108, that lists the file creation dates, modified time, for all the media files on the player. The Mantis then identifies which files are the oldest and determines if they are used by any of the incoming playlists. If the MPEG file is not used, the Mantis deletes it.



### **Determine if All Media Files Transferred Successfully**

Download the log files from the Mantis player. One of the logs downloaded is the Content Log which lists all the media files currently stored on the Mantis.

## 6 System Update Check

After the Mantis finishes its content update routine, it searches for any valid software updates on the disc. A software update file has a (.upd) extension and may update one or more Mantis players.

If the Mantis finds a (.upd) file, it copies the file to its hard drive and then executes the update.

For more on the behavior of each (.upd) file refer to the software release notes that came with the update file.

## 7 System Software Update Process

If a CD/DVD disc fails to qualify as a media update or a Drop & Go update, the Mantis determines if it is a system software update. To qualify as a system software update, the disc must contain a file with the extension “.upd”. If such a file is found, Mantis processes the software update, ejects the disc, and then waits 60 seconds before implementing the update and restarting.

If no valid (.upd) file is found, Mantis takes no further action.

## Content Log

Once every 24-hours, the media player creates a content log that lists all of the content files stored on the player. This log is an ASCII delimited file that provides the media name (filename), file size in bytes, and mtime (file creation time).

*mtime* is , the file creation time, or *modified time* in a Linux format. During the storage cleanup routine, the Mantis uses the file modification time to determine which files should be removed to open up free space for new content.

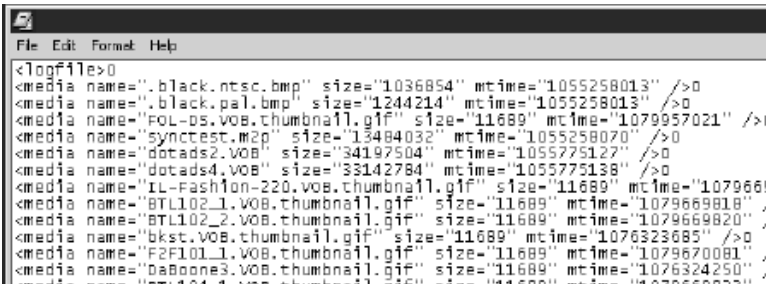

```
<logfile>0
<media name=".black.ntsc.bmp" size="1036854" mtime="1055258013" />0
<media name=".black.pal.bmp" size="1244214" mtime="1055258013" />0
<media name="POL-DS.VOB.thumbnail.gif" size="11689" mtime="1079957021" />1
<media name="synctest.m2p" size="13484032" mtime="1055258070" />0
<media name="dotads2.VOB" size="34197504" mtime="1055775127" />0
<media name="dotads4.VOB" size="33142784" mtime="1055775138" />0
<media name="IL-Fashion-220.VOB.thumbnail.gif" size="11689" mtime="1079661
<media name="BTL102_1.VOB.thumbnail.gif" size="11689" mtime="1079669818"
<media name="BTL102_2.VOB.thumbnail.gif" size="11689" mtime="1079669820"
<media name="bkst.VOB.thumbnail.gif" size="11689" mtime="1076323685" />0
<media name="F2F101_1.VOB.thumbnail.gif" size="11689" mtime="1079670081"
<media name="DaBoone3.VOB.thumbnail.gif" size="11689" mtime="1076324250"
<media name="DaBoone4.VOB.thumbnail.gif" size="11689" mtime="1076324250"
</logfile>
```

Figure 1. Content Log File

The Content Log is one of the files downloaded from the Mantis when uploading log files.

# Automatic Updating

## Media Update Disc Updating

The benefits of using media update discs are:

- ❑ Media update discs require no specialized knowledge to use. Insert the disc and Mantis performs all the tasks.
- ❑ One media update disc can have site-specific information for multiple unique locations and eliminates the need to make a different disc for each location.
- ❑ Media update discs permit the creation of multi-disc sets in cases where the size of the content exceeds the capacity of a single disc.

## Creating a Media Update Disc

Creating a media update disc requires the Visual Circuits Media Messenger application and CD/DVD writer software.

Media Messenger generates an update packet file (.tar), which can be copied to a CD/DVD using any standard CD/DVD writing program, such as Nero or Disc Juggler.

1. Using Media Messenger, create a (.tar) file from the playlist (.fpl) and schedule (.fsc) files. Media Messenger creates the files necessary for the disc to act as an Autorun program.
2. Using a common CD/DVD writer program, write the (.tar) file and all of the media, MPEG's and graphic overlay files, to the root-level of the CD/DVD. There should be no directories on the media update disc.



### **Test Network Speed**

If writing a CD/DVD requires transferring files over a network during the writing process, test network performance to insure that the transfer rate is fast enough to avoid CD/DVD writer errors.

3. Test the disc in a Mantis to verify that it works, before making duplicates and distributing to other sites.



#### **Conversion of Graphics Files to 24-bit Format**

When WebView makes a copy of a .jpg, .gif, .tif, .tga, or non 256-color .bmp image file, to the Mantis, it converts the file to a standard 24-bit format and automatically determines the correct image size for the selected output standard, for example 720 x 480 for NTSC. The Mantis stores the original image and uses it as the thumbnail that is displayed in the various WebView editing windows

If you do not want your images to be converted by Mantis, create them according to the parameters outlined above before transferring.

## **Using a Media Update Disc**

Use the following steps to perform a CD/DVD update:

1. Open the player's CD/DVD drawer and insert the disc.
2. Close the CD/DVD drawer and the update proceeds automatically.
3. The Front Panel Display indicates when the update is complete and the disc ejects automatically.
4. If there are several updates to be completed, use as many media update discs as required to perform the update. Insert the discs one at a time. After each disc's update is complete, the player ejects the disc automatically.



#### **Test Master Update Disc**

As a precaution, test the master disc before duplication and distribution of the media update discs going into the field. In addition, review CD/DVD update creation information and always check videos for assured quality.

## Drop & Go Disc Updating

### Drop & Go Basics

When the Mantis loads a Drop & Go disc, the videos are copied to the Mantis and playback begins automatically. Depending on the number of videos to be copied and the length of each video, the copying process can take several minutes. During the copying process, the old videos continue to play and the Front Panel Display indicates copying progress.

### Creating a Drop & Go Playback Disc

Create a Drop & Go disc by copying MPEG videos onto a CD/DVD disc using any Windows or Linux-based computer with a CD or DVD writer.

1. A Drop & Go disc must contain 4 root-level directories with the names *channel 1*, *channel 2*, *channel 3*, and *channel 4*. These names are not case-sensitive. Moreover, the names are recognized whether they include a space between the word channel and the number or not: *channel 1* is okay too.
2. Copy the videos for each channel into the appropriate directory. The videos placed in each directory play back on the corresponding channel: files in directory Channel 1 play back on channel 1 of the Mantis. Video playback for each directory is in alphanumeric order.



The existence of additional directories, sub-directories, and non-video files is ignored and does not prevent the proper operation of the Drop & Go feature.

## Using a Drop & Go Playback Disc

To use the Drop & Go disc:

1. Insert the Drop & Go disc into the Mantis CD/DVD drawer and close the drawer.
2. The Mantis detects the Drop & Go disc and begins copying the videos.
3. The Mantis creates the playlist, “dropngo.fpl”.
4. The Front Panel Display shows: **CD Copying:** and displays the filename of the file being copied.



### **Mantis Cleanup Routine**

When writing MPEG files to its internal storage, the Mantis runs a cleanup routine to insure that there is enough space for the new files. For more details, refer to *5 Mantis Storage Cleanup Routine* on page 107.

### **Determine if All Media Files Transferred Successfully**

Download the log files from the Mantis player. One of the logs downloaded is the Content Log which lists all the media files currently stored on the Mantis, see *Content Log* on page 108

5. Once the Mantis copies all the videos, playback of the new content begins.



There is a brief pause and blackout before the new content begins playing.

6. Manually eject the Drop & Go disc.

## FTP Updating

FTP, *File Transfer Protocol*, is a standardized convention used to deliver digital data via, TCP/IP., a set of network protocols commonly used by networking systems and the internet.

Using FTP, each Mantis updates itself automatically when connected to a static network connection. New media, playlists, schedules and/or system updates are downloaded using this connection to a FTP site. Static network connections may be DSL, cable modem, or a connection to a Local Area Network (LAN). Often LAN connections have access to the Internet. However, check with a networking specialist for information on setting up an account, if Internet access is required to reach the FTP server. Often, Internet access from a LAN requires the use of a proxy server and fire wall permissions.



### FTP Software

Although there are many types of FTP software packages available, Visual Circuits recommends Serve-U. You can download a trial version at [www.Serve-U.com](http://www.Serve-U.com)

## FTP Server

FTP servers are programs that reside on a PC and may be Windows, Unix, or Linux-based. A FTP server monitors users that log in to it and regulate what folders and videos a user may access. When a Mantis performs an update, the FTP server sees it as a user.



### Mantis Site ID

Setup each Mantis with its own site ID before installation. This permits future update files created for that specific Mantis to have filenames using its unique site ID.

For a Mantis to perform an update, it must be configured with the network address of the FTP server and login information ,username and password, for an account on the FTP server. The account should have read and write permissions on the FTP server.

## Player Management

Player management is easy and does not require a technical networking background. Most helpful is that the person responsible for player management be familiar with the presentations and understand what content should play on each channel. It is important to post scripts and videos to the correct directories at the update location. The player manager can then provide a quality control function by ensuring that the correct files are maintained and saved in the appropriate directories.

## Creating a Mantis FTP Update Account

After the Mantis logs in, it begins looking for the following directories for updating:

/

All media files are posted in the Login directory, unless the **Directory** control in the FTP Auto-Update settings is used, see *Directory* on page 87, in which case the Mantis changes that directory after logging in.

### **/scripts**

Post all update packet files with (.tar), (.fpl) or (.fsc) extensions to the `/scripts` directory.



#### **Posting Either Update Packet or Playlist**

Typically, either a single update packet is posted for all players to download or a playlist is posted for each Mantis. Each time a download occurs, playback is interrupted for several seconds as playback is reset with the new playlist.

### **/updates**

Post all system software updates, files with a (.upd) extension, to the `/updates` directory. This software update for the player automatically takes effect and resets playback. System software is version controlled, see *System Settings* on page 71.



## FTP Update Process

When a FTP update is initiated on the Mantis, either by selecting **Update Now** from the menu system or by a regular update interval or fixed time trigger, the Mantis attempts to establish communications with the specified FTP site.

When communication is established, the Mantis searches the home `/scripts` directory for update packet files intended specifically for that particular Mantis. The filename is the site ID for the Mantis performing the update. For example, if the site ID of the Mantis is *location1*, the Mantis looks for a file *location1.tar*. When the Mantis finds the file, it copies it and then progresses to the playlist parsing routine, see page 106.

However, if the Mantis does not find an update packet file, it then searches for a generic package file with the filename *firefly.tar*. When the Mantis finds this file, it copies the file and moves on to the parsing routine, see next page.

## FTP Updating Order

The Mantis system looks for an update file following a specific order. It proceeds sequentially through the order until it finds a matching file and then proceeds to the playlist parsing routine, see below.

1. *siteid.tar*
2. *firefly.tar*
3. *siteid.fpl*
4. *firefly.fpl*
5. *siteid.fsc*
6. *firefly.fsc*

## Playlist Parsing Routine

When the Mantis copies a new playlist, it analyzes the list to determine which MPEG video files it needs. The Mantis then checks its own storage to determine if any of these videos are already present. Any files that are not present are copied from the FTP site.

For a preexisting file, the Mantis compares its file size against a file with the same name located on the FTP site. Only if the file on the FTP site has a different file size, does the Mantis copy it and overwrite the pre-existing file, see page 106 for file size criteria.

Once all of the required video files are copied from the FTP site, the Mantis begins playing the new playlist or schedule.

## System Update Check

After the Mantis finishes its update routine, it searches for any valid software updates in the `/updates` directory, in the FTP site's home directory: see page 107 for more information on system update checks. If the Mantis finds a `(.upd)` file in the `/updates` directory, it copies the file to its hard drive and then executes the update.

For more on the behavior of each `(.upd)` file refer to the software release notes that come with the update file.

## Multicast Updating

The following is for Mantis media players that have the optional KenCast™ Fazzt multicast client enabled. The KenCast multicast client handles the task of receiving and writing media files to the Mantis's internal storage.



Multicasting is an optional feature enabled by a pre-programmed Smart Card.

If your Mantis does not have the Multicasting feature (menu items are “grayed out”) and you would like to purchase it, contact a Visual Circuits representative at 1-800-250-5533. For specific information about multicasting and KenCast, please refer to documentation for those products.

In addition, throughout the Multicast Updating section, there are references to the term *script*. For the purpose of this section, a script is made up of a playlist (.fpl) file and/or an update packet (.tar) file.

### Overview

When the multicast-enabled Smart Card is inserted into the Mantis, the Mantis loads a license for the KenCast multicast client software onto the system. When the Smart Card is removed, the licensing and all multicast functionality is disabled. It is necessary for the Smart Card to be in the card reader for the application to work. For more information about Smart Card, see *Smart Card* on page 23.

Each Mantis on the network must have a unique serial number. These serial numbers identify the individual Mantis players during a multicast update and ensure that the proper media goes to the correct player.

With the Mantis, two multicast modes are available: Package Mode and Script Last Mode.

### Package Mode

1. In Package Mode, a *Fazzt* package must be created and sent to the Mantis system.

The *Fazzt* package must contain a scrip, i.e. playlist (.fpl) or update packet (.tar.) The inclusion of videos and graphic overlays is optional. Any videos or graphic overlays not referenced by the script will be deleted upon arrival.

2. After the transfer is complete, the Mantis runs the cleanup routine which reduces the amount of content on the system and maintains the *Reserve MBs* free space, see *Reserves MBs* on page 120 for details. The Mantis uses this free space to store the next incoming multicast transfer.

If the same package is sent to all Mantis on the network, it is possible to remove all unnecessary content by using the standardized site ID naming convention for the scripts used, see *Overview of the Update Process* on page 104 for more information.

### Script Last Mode

1. In Script Last Mode, individual files are sent to the Mantis. Any content stored on the system (unless none of its files are on the system). Any (.tar) or (.fpl) sent is processed and played as long as it has at least one content file on the Mantis.
2. Script Last Mode allows you to simply “send content” to the Mantis to load it, without the need for a script. This is made possible because auto-deletion of content is not performed, other than the standard cleanup routine, see page 107 for details.
3. Whether all content is sent to all sites is determined by the head end software.
4. Moreover, with multicast updating, new schedules and playlists play immediately on the Mantis.



Do not to mix update files (.upd) with content files when completing multicast updating.

## Software Update Check

A software update check searches for any valid software updates, see page 107 for more details.

If a Mantis receives a (.upd) file during a multicast transmission, the system will apply the update.

## System Settings for Multicasting

The System Settings for Multicasting detailed below are accessible via either the remote control, WebView or Front Panel interfaces.



### Enabling Changes Made to Multicast Settings

Whenever changes are made to multicast settings, it is necessary to switch the **Client Enable** setting from *Disable* to *Enable* to activate the new settings.

### Client Enable

Allows the enabling or disabling of the KenCast multicast client.

### Listen Address

The IP address that the multicast client listens to. The value must be a Class D multicast address, which typically starts with 224.xxx.xxx.xxx.

Because some addresses may be reserved (see below), consult the network administrator for assistance.

224.0.0.0/24 is reserved by RFC.

224.0.1.0/24 is used by specific applications (NTP).

### Listen Port

The port address that the multicast client will listen on.

### Transfer Order

Allows choosing the order in which items are transferred: package mode (see page 118 for details) or script last mode (see page 118 details).

**Reserves MBs**

Allows the allocation of a fixed amount of the Mantis's internal storage space for receiving a multicast update. To determine this value, you will need to estimate the largest multicast update you will ever receive (example: 1000 MBs). Then, double that amount (example:  $1000 \text{ MBs} \times 2 = 2000 \text{ MBs}$ ) to allow room for both the compressed archive and the extraction process. Once you have determined this value, enter it for the Reserve MBs.

# Manual Updating

## WebView Updating

WebView is a web-based interface that can be used to transfer media from a local computer and/or the network to the Mantis. See *Transferring Media* on page 36 for instructions on transferring media to the Mantis using the WebView interface.

In addition, WebView may be used to create, edit or delete playlists and/or schedules. See *Using the Playlist Editor* on page 42 for information on working with playlists or *Using the Schedule Editor* on page 50 for information on working with schedules.

## Standard CD/DVD Updating

Standard CD/DVD discs containing MPEG and graphic overlay (.bmp, .jpg, .gif, .tga or .png) files can be used to manually update the media on your Mantis.

Use any standard CD/DVD writing program and CD/DVD writer to create a disc.

1. Copy MPEG and graphic overlay files to a folder on the PC with the CD/DVD writer. When writing CD's/DVD's over a network, test the network speed.
2. Write all files to the CD/DVD.
3. Test the disc in a Mantis prior to making duplicates and distributing to sites.



While copying .jpg, .gif, .tga, .png or non 256-color .bmp image files, the Mantis converts those files to a standard 24-bit bitmap format. This is necessary to ensure that all image files used for graphic overlays are consistent in appearance and functionality. As a result, all image files listed under "Loaded Media" will appear with ".bmp" as their extension.

If you do not want your images to be converted by the Mantis, create them according to the parameters outlined above before transferring.

## Direct File Access Updating

Direct File Access (enabled in “Web” screen within the Mantis System Settings) can be used to update the Mantis directly with an FTP client. Programs such as FlashFXP (see description below) may be used.

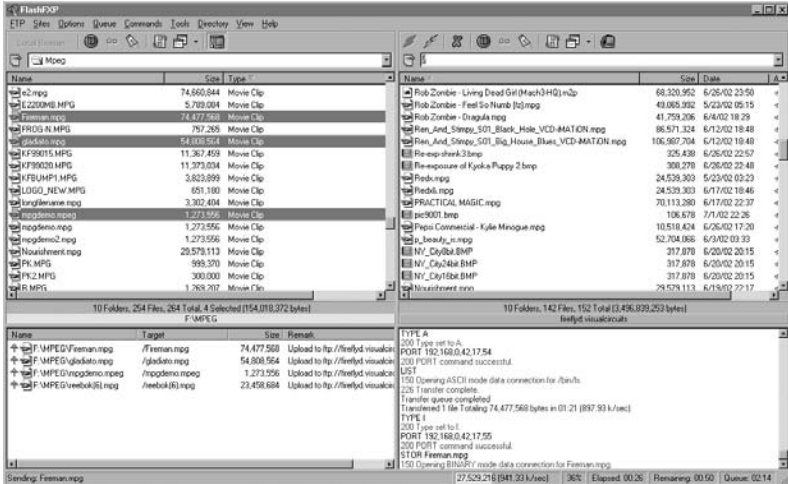

Figure 2. Example of Direct File Access Using FlashFXP

Direct File Access is a powerful way to work with the Mantis. Using a program such as FlashFXP, the local PC hard drive or computer network appears on the left pane with the Mantis appearing on the right.



### Security Warning

The File Access feature is disabled by default because of an inherent security risk. By enabling File Access, you are opening the FTP port, which opens your Mantis up to potential unauthorized access via a network, such as the internet. Understand that all security provisions must be provided by your network. The Mantis does not include any special security measures for this feature.



Some of the options available include:

- ❑ Viewing the contents of the Mantis.
- ❑ Deleting files from the Mantis.
- ❑ Downloading files from the Mantis to a PC or network.
- ❑ Uploading files from a PC or network drive to the Mantis.



**Caution**

While using an FTP client, keep in mind that you will be able to view and access special system file sub-directories that should remain unaltered. To prevent potential damage to the operation of your Mantis Media Player, do not open or delete any files from



# LOG FILE REPORTING

## Overview

Mantis media players offer the ability to log periodic data for the purpose of system diagnostics and the verification of program playback. This logging function is a powerful management tool for the Mantis media player network.

The two types of data collection available are Run and Diagnostic. They can be run singly or together. The settings for log file reporting are in the **System Settings** menu which is accessible via WebView or the system front panel, see *Logging Settings* on page 84.

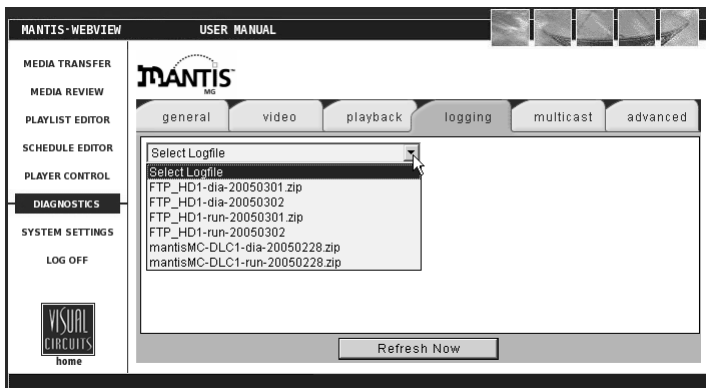

**Figure 1.** Example of WebView's Logfile Viewer  
(refer to *Diagnostics - Logging* on page 68)

When enabled, the Mantis generates daily logs of the desired data and stores them as zipped archive files. These logs are created at the end of the day, just before midnight (24:00:00).

## Run Logs

time	ch	filename	overlay	duration	%
23:59:51	2	forourdaughters.mpg		00:00:32	100
23:59:50	1	forourdaughters.mpg		00:00:31	100
23:59:19	2	forourdaughters.mpg		00:00:31	100
23:59:19	1	forourdaughters.mpg		00:00:32	100
23:58:48	2	forourdaughters.mpg		00:00:32	100
23:58:47	1	forourdaughters.mpg		00:00:31	100
23:58:15	2	forourdaughters.mpg		00:00:31	100
23:58:15	1	forourdaughters.mpg		00:00:32	100
23:57:44	2	forourdaughters.mpg		00:00:32	100
23:57:43	1	forourdaughters.mpg		00:00:31	100

**Figure 2.** WebView Run Log Report Form

A Run Log provides a record of which videos played, along with;

- Playback of any associated graphic overlays,
- Channels on which playback occurred,
- Starting dates and times,
- Percentage of the video played back,
- Duration of play,

Typical uses for Run Logs are to;

- Verify playback schedules,
- Demonstrate compliance with paid playback agreements,

## Diagnostic Logs

time	source	event
23:59:56	system	Chan 2: Data Underflow 0
23:59:56	system	Chan 2: Disk Underflow 0
23:59:56	system	Chan 2: AV Syncs -1109395996
23:59:56	system	Chan 1: Data Underflow 0
23:59:56	system	Chan 1: Disk Underflow 0
23:59:56	system	Chan 1: AV Syncs -1109395996
23:59:56	system	Space Avail: 21961793536 bytes
23:59:56	system	Space Used: 18090479616 bytes
23:59:56	system	System Starts: 0
23:59:56	system	Watchdog Restarts: 1

**Figure 3.** WebVDR Diagnostic Log Report Form

A Diagnostic Log provides a record of all media update transactions and any Mantis system errors.

Data contained in a Diagnostic Log includes:

- ❑ **FTP/DVD Updating**  
This record tracks the date and time of connect/disconnects, errors- yes/no, files, sizes and percent transferred.
- ❑ **Storage Cleanup**  
This record notes what files have been deleted by the automatic storage cleanup routine, and include their filenames, sizes and dates.
- ❑ **Missing Elements**  
This record lists all missing media referenced by an active playlist or schedule, and includes date, time and file element.
- ❑ **Error Summary**  
This record captures important user player diagnostic information, and includes the number of system restarts, number of watchdog restarts, the player version, and more.

## Log Formats

### Run Logs

The available output formats for a Mantis run log file are either CSV or XML.

#### Sample Run Log, .CSV Format

```
12-07-02 20:30:07,1,05saturn.mpg,3_ser220.BMP,1,00:01:01,100
```

#### Sample Run Log, .XML Format

```
<mpeg datetime="12-07-02 20:32:57" chan="1"  
filename="05saturn.mpg" overlay="3_ser220.BMP" loop="1"  
duration="00:01:01" percent="100" />
```

### Diagnostic Logs

The format of a Diagnostic Log is in a time /event per line format.

### DTDs (Document Type Definition)

To import data from a log file into a database, use one of the DTDs available from Visual Circuits website:

[www.visualcircuits.com/dtds/diaglog.dtd](http://www.visualcircuits.com/dtds/diaglog.dtd) (Diagnostic Log)

or

[www.visualcircuits.com/dtds/runlog.dtd](http://www.visualcircuits.com/dtds/runlog.dtd) (Run Log).

### Log Default Playlist

Log file reporting offers the option to include the default playlist playback in the playback log file data.

Choosing **Yes** includes the default playlist in the playback data.

## Maximum Log File Size

By default, the maximum space available to store all the log files is 10 MB. This maximum is adjustable. As the Mantis generates log files, it compares the storage area in use against the maximum allowed.

If the latest log file exceeds the allowed storage capacity, the Mantis initiates an automatic cleanup process that deletes the oldest log file(s) to free the necessary space for the newest log file.

In addition, files are deleted after they are transferred to the FTP server or downloaded from the Mantis player.

**Tip**

If storage space for video and graphics is an issue, set the maximum storage capacity smaller and download the log files more frequently.

## Uploading Log Files

The Mantis offers the ability to access its log files locally.

### Upload to FTP Server

On the WebView Settings Page chose **Upload Logs** and the Mantis automatically uploads its log files to the FTP server designated in the System Settings, FTP Auto-Update, see *FTP Auto-Update Settings* on page 87.

The name for the target directory on the server must be *logfiles*.

## **Download to Local Computer**

The Media Messenger application provides the ability to download and access the Mantis log files on a local computer. Refer to the Media Messenger User Manual for details.



# EXTERNAL CONTROL COMMANDS

---

## Overview

To configure the Mantis control settings it is necessary to access the Mantis via either its RS232 or Ethernet port and manually enter the commands using an ASCII control program such as Windows Hyper Terminal.

There are two types of external control commands described in this section: Visual Circuits Corporation (VCC) control commands and Laserdisc emulation (LDV) control commands.



VCC control commands are proprietary and are not designed to be mixed with the LDV commands. Combining the two could cause inconsistent results and is not recommended.

The following list of commands may be sent via RS232 or TCP/IP to the Mantis to direct playback. Any standard show control system or ASCII generating control program may be used. For RS232 it is recommended to use a null modem cable. For TCP/IP connections consult the control device specification to see if a cross over network patch cable is required.

When specifying a channel, the first channel is referred to as 0 (zero), Channel 2 = 1, (etc.).

## Connecting via RS232

- ❑ The RS232 9-pin, D-sub connector is located on the back of the Mantis.
- ❑ Configure the Control Settings, see *Control Settings* on page 76, to be compatible with your show controller.

## Connecting via TCP/IP

1. Set **Accept TCP/IP** to **Yes** in the Control Settings screen.  
This allows anyone on the network to send commands to the Mantis if they know its network address.  
The TCP/IP (ethernet) connector is located on the back of the Mantis to the right of the RS232 connector.
2. Configure the network settings, see the section on *Network Settings* on page 78 for details on how to do this.
3. Connect to port 2180.

## Hyper Terminal Basics

Inputting external commands requires

- ❑ Laptop or other computer
  - ❑ Hyper Terminal: all Windows machines contain under *Start/Programs/Accessories/Communications*
  - ❑ Null modem cable: female 9-pin, D to female 9-pin, D, RS-232 cable
1. Connect the laptop to the Mantis using the null modem cable.
  2. Start Hyper Terminal.
    - a. Select Com 1 and 9600BPS.
    - b. Press **Enter** and a NAK appears on the screen.  
If this takes a long time or does not happen at all, recheck the connection and verify that COM 1 is enabled in the computer's BIOS. Verify that no other application is using COM 1.
    - c. After establishing the connection, select the *File/Properties/Settings Tab/ASCII Setup* button.
    - d. Select the **Echo typed characters locally** box and select **OK** twice.
  3. Proceed with typing in the syntax desired. ACK indicates a correct response. Do not attempt to correct errors, press **Enter** and re-enter the command. Consult the Hyper Terminal Help file or see your Network Administrator for further assistance.



Upon initial start up, the Mantis automatically begins playing the latest loaded playlist/schedule.

To choose to begin playback manually via the External commands, set this option its default **No**.

# VCC Control Commands



## Filename Conventions

The Mantis provides three interfaces, that allow the creation and naming, or transferring of files: front panel controls, WebView, and External Control Commands. To insure compatibility between them, filenames must conform to the following conventions:

- up to 214 alphanumeric characters (capitals and lowercase) in length
- can include spaces dashes, and underscores
- can begin with either alpha or numerical character

## Playlist Playback Commands

### Playlistload

The *Playlistload* command loads a playlist and prepares it for playback. Use this command to initiate the precise timing of playback. To start playback, use the *mpgPlay* or *mpgPlayAll* command.

### Syntax

`Playlistload name once`

### Parameters (optional)

*name*

Name of the playlist file (e.g., loop1.fpl). It is not necessary to include the .fpl extension.

*once*

0 loads the playlist endlessly (default).

1 loads the playlist once through and then stops.

## Playlistplay

The *Playlistplay* command automatically loads the playlist and initiates playback once the files are fully queued and loaded. There may be a slight delay between this command and the start of playback.

The difference between the *Playlistplay* and *Playlistload* commands is that *Playlistplay* starts playback automatically, whereas *Playlistload* only loads the playlist and then requires the *mpgPlayall* command to start playback. *Playlistload* provides precise control of the time that playback begins.

### Syntax

```
playlistplay name once
```

### Parameters (optional)

*name*

Name of the playlist file (e.g., loop1.fpl). It is not necessary to include the .fpl extension.

*once*

0 loops the playlist endlessly (default),  
1 plays the playlist once through and stops,

### Remarks

- Use for playing individual files.

## mpgLoad

The *mpgLoad* function opens an MPEG file and prepares it for playback. If an MPEG is currently playing on the specified channel, playback is interrupted.

- ❑ *videoname* should include the storage path.
- ❑ If files are stored locally on the player, no storage path designation is required.

### Syntax

```
mpgLoad 0 channel videoname
```

### Parameters

*channel*

The channel on the media player (0-3)

*videoname*

The storage path and video name of the MPEG file to load. If no path is designated, the media player defaults to local storage.

### Return Values

This command returns

ACK if the file load was started successfully,  
NAK if the file could not be loaded (e.g., the file was not found).

## mpgLoadNext

The *mpgLoadNext* function sets the specified channel to start another file immediately when the current one finishes.

### Syntax

```
mpgLoadNext 0 channel videoname
```

### Parameters

*channel*

The channel on the media player (0-3)

*videoname*

The full path and video name of the MPEG file to load.  
(See description for *mpgLoad*.)

### Return Values

This command returns

ACK to indicate that the file was loaded successfully, or  
NAK to indicate that the file could not be loaded (e.g., the  
file was not found).

### Remarks

- ❑ This function allows for a seamless transition between two MPEGs.
- ❑ A good time to call it is when the preceding file begins to play: when the driver sends a `MPG_FILE_READ_START` message to the application, call *mpgLoadNext*.

## mpgLoadDef

The *mpgLoadDef* command loads an MPEG file for playback on the specified channel but does not play the file.

- ❑ *videoname* should include the storage path.
- ❑ If files are stored locally on the media player no storage path designation is required.
- ❑ This command loops the file indefinitely.

### Syntax

```
mpgLoaddef 0 channel videoname
```

### Parameters

*channel*

The channel on the media player (0-3)

*videoname*

The storage path and video name of the MPEG file to load. If no path is designated, the media player defaults to local storage.

### Return Values

This command returns

ACK if the file load was started successfully, or  
NAK if the file could not be loaded (e.g., the file was not found).



## **mpgLoadNextDef**

This command queues an MPEG file to play when the current video file finishes. This command adds the file to a looping playlist.

### **Syntax**

```
mpgLoadNextdef 0 channel videoname
```

### **Parameters**

*channel*

The channel on the media player (0-3)

*videoname*

The full path and video name of the MPEG file to load.  
(See description for *mpgLoad*.)

### **Return Values**

This command returns

ACK to indicate that the file was loaded successfully, or  
NAK to indicate that the file could not be loaded (e.g., the  
file was not found).

## **mpgClearDef**

The *mpgClearDef* command clears the default (looping) playlist by canceling the playlist defined by *mpgLoadDef* and *mpgLoadNextDef* and the playlist loaded by the media player at startup.

### **Syntax**

```
mpgClearDef 0 channel
```

### **Parameters**

*channel*

The channel on the media player (0-3)

### **Return Values**

This command returns

ACK if the file load was started successfully, or  
NAK if the file could not be loaded (e.g., the file was not found).

## **mpgPlay**

The *mpgPlay* function starts playback on a channel. The file must have been loaded using the *mpgLoad* command.

### **Syntax**

```
mpgPlay 0 channel
```

### **Parameters**

*channel*

The channel on the media player (0-3)

### **Return Values**

This command returns

ACK if playback was started successfully, or

NAK if playback could not be started (e.g., no file previously loaded).

### **Remarks**

The MPEG must have been opened first by *mpgLoad*.

## mpgStop

The *mpgStop* command stops playback of an MPEG file playing on the specified channel.



Unlike other APIs from Visual Circuits, once a file has been stopped with this command, it can not be restarted. The file must be reloaded and restarted. The video plays from its beginning.

### Syntax

```
mpgStop 0 channel
```

### Parameters

*channel*

The channel on the media player (0-3)

### Return Values

This command returns

ACK if playback was stopped successfully, or  
NAK if playback could not be stopped (e.g., no file currently playing).

### Remarks

- ❑ The MPEG must have been started with *mpgPlay* or *mpgPlayAll*.

## **mpgPlayAll**

The *mpgPlayAll* function starts or resumes playback on all channels on all installed cards.

### **Syntax**

`mpgPlayAll`

### **Parameters**

None

### **Return Values**

This command returns

- ACK to indicate that playback started successfully, or
- NAK to indicate that playback did not start on all channels.

### **Remarks**

The MPEG files must have been opened first by *mpgLoad*.

## mpgStopAll

The *mpgStopAll* function stops playback on all channels on all installed cards.



Unlike other APIs from Visual Circuits, once a file has been stopped with this command, it can not be restarted. The file must be reloaded and restarted. The video plays from its beginning.

### Syntax

```
mpgStopAll
```

### Parameters

None

### Return Values

This command returns

ACK to indicate that all channels stopped successfully, or  
NAK indicates that all channels did not stop.

## mpgBlack

The *mpgBlack* command covers MPEG video on a channel, causing the corresponding video display to go black.

To uncover the video, use the *mpgUnblack* command.



This black may not be recognized by all displays as a true video signal.

### Syntax

```
mpgBlack 0 channel
```

### Parameters

*channel*

The channel on the media player (0-3)

### Return Values

This command returns

ACK if *mpgBlack* was started successfully, or  
NAK if *mpgBlack* could not be started.

### Remarks

- ❑ Video playback is independent of whether the video is muted with *mpgBlack* or not. The videos continue to play underneath the black, audio is unaltered, and callbacks continue being sent normally.
- ❑ If a playlist is played with one of the commands, such as *playlistPlay*, unused channels (channels with no video files) are set to the blackened state. Therefore, it is necessary to call *mpgUnblack* on those channels if they are to play video using commands such as *mpgLoad/mgpPlay*.

See *mpgUnblack* on page 146 for more information on “unblackening” video.

## **mpgUnblack**

The *mpgUnblack* command uncovers MPEG video, reversing the effects of the *mpgBlack* command.

To cover the video again, use the *mpgBlack* command.

### **Syntax**

```
mpgUnblack 0 channel
```

### **Parameters**

*channel*

The channel on the media player (0-3)

### **Return Values**

This command returns

ACK if *mpgUnblack* started successfully, or

NAK if *mpgUnblack* could not start.

### **Remarks**

See *mpgBlack* on page 145 for more information on blacking out video.



## Using Serial Commands To Create Playlists



### Filename Conventions

The Mantis provides three interfaces, that allow the creation and naming, or transferring of files: front panel controls, WebView, and External Control Commands. To insure compatibility between them, filenames must conform to the following conventions:

- up to 214 alphanumeric characters (capitals and lowercase) in length
- can include spaces, dashes, and underscores
- can begin with either alpha or numerical character

Create playlists “on the fly” with the *mpgLoadDef* and *mpgLoadNextDef* commands. Use these two commands to define a default (i.e. looping) playlist of MPEG files on any given channel.

To make a playlist on a single channel:

1. call *mpgClearDef* to clear the old default playlist.
2. call *mpgLoadDef* to specify the first file in the list.
3. call *mpgLoadNextDef* once for each additional file, the order they should play.
4. wait a few seconds for the files to load.
5. call *mpgPlay* to start playback.

If you want to create a playlist that only plays once, use the *mpgLoad* and *mpgLoadNext* commands as follows:

1. call *mpgClearDef* to clear the old default playlist.
2. call *mpgLoad* to specify the first file in the list.
3. call *mpgLoadNext* once for each additional file, the order they should play.
4. wait a few seconds for the files to load.
5. call *mpgPlay* to start playback.

To interactively insert into the default playlist files that play only one time, use the *mpgLoad* and *mpgLoadNext* commands **without** calling *mpgClearDef*. A list of files specified with these commands interrupts the default playlist and plays it once. When the last specified file ends, the default playlist resumes from the point where it was interrupted.

The last value passed to *mpgSetInitOnOpen* effects the type of transition when *mpgLoad* or *mpgLoadDef* is called. For seamless transitions, send *mpgSetinitOnopen* 0 before the load commands.

## Firefly System Commands

### FireflyFtpUpdate

This command enables the media player to update video content, playlists/schedules and software via an FTP server.

See *FTP Update Process* on page 115 for more information.

### FireflyRestart

This command restarts the entire media player system. This process normally takes about one minute to complete.

## Callback Commands

### mpgCallback

The *mpgCallback* function requests that callback messages be sent to *hwnd*.

#### Syntax

```
mpgCallback on
```

#### Parameters

*on*

*on*=1, send callbacks (default off).

### Play Complete Callback

Each time a file ends on a channel and another file is started, a string is sent back to the controller over the serial port. This string has the following format:

```
CB 0 channel 2
```

0 is the player channel.

2 equals the end of the file.

## Audio and Video

### **mpgSetVolumeLeftRight**

The *mpgSetVolumeLeftRight* command sets the left and right audio volumes independently. The default volume level is *124*: the lower the number, the softer the volume.

#### **Syntax**

```
mpgSetVolumeLeftRight 0 channel leftVolume  
                        rightVolume
```

#### **Parameters**

*channel*

0 based index of the channel on the media player.

*leftVolume*

0-255 the audio level on the left channel.

*rightVolume*

0-255 the audio level on the right channel.

## **mpgMute**

The *mpgMute* command turns off the audio.

### **Syntax**

```
mpgMute 0 channel
```

### **Parameters**

*channel*

0 based index of the channel on the media player (0-3).

## **mpgUnMute**

The *mpgUnMute* command turns on the audio.

### **Syntax**

```
mpgUnMute 0 channel
```

### **Parameters**

*channel*

0 based index of the channel on the media player (0-3).

## On-Screen Display Commands

### osdLoadBMP

The *osdLoadBMP* command will load a 256 or 16 color Microsoft bitmap (BMP) format file for overlay on the specified channel.

#### Syntax

```
osdLoadBMP 0 channel filename XPos YPos Mix  
          xColor
```

#### Parameters

*channel*

0 based index of the channel on the media player (0-3).

*filename*

Path of BMP file.

*XPos*

Position along x-axis.

-1 to center horizontal

-2 to align on the right edge

*YPos*

Position along y-axis.

-1 to center vertical

-2 to align on the bottom edge

*Mix*

Level of transparent color. (0-255)

0 for invisible.

*xColor*

Palette color in the BMP to make transparent. (0-255)

-1 for all pixels equally transparent according to mix

#### Remarks

- ❑ The position (0,0) is located in the upper left corner of the video display.



- ❑ There is no certain way to predict the color represented by the *xColor* argument. It is determined by the method that the bitmap palette was generated. If you cannot view the palette of the file with your graphics editor, the only way to see which *xColor value* effects which color is through trial and error.
- ❑ When *Mix* is zero, the transparent color is completely transparent. When it is 255, the transparent color is not transparent at all. When it is a number in between, the transparency level is also somewhere in between. Use the command *osdSetColorMixes* for more advanced control over the transparency.
- ❑ This command will only load the BMP, but not actually display it. To display it, use *osdShow* after *osdLoadBMP*.
- ❑ In order for the BMP to display properly, there must be an MPEG file underneath. It need not be playing, however.
- ❑ This command loads VCC proprietary binary format BIN files.

## **osdShow**

The *osdShow* command will display a previously loaded on-screen BMP.

### **Syntax**

```
osdShow 0 channel
```

### **Parameters**

*channel*

0 based index of the channel on the media player (0-3).

### **Remarks**

The channel must first have an image loaded using one of the *osdLoad* commands.

## **osdHide**

The *osdHide* command will hide a BMP image which is currently being shown on the specified channel.

### **Syntax**

```
osdHide 0 channel
```

### **Parameters**

*channel*

0 based index of the channel on the media player (0-3).

### **Remarks**

The channel must first have an image loaded using one of the *osdLoad* commands., and it must be shown using *osdShow*.

## osdSetXYMix

The *osdSetXYMix* command will load a BMP for overlay on the specified channel.

### Syntax

```
osdSetXYMix 0 channel XPos YPos Mix
```

### Parameters

*channel*

0 based index of the channel on the media player (0-3).

*XPos*

Position along x-axis.

-1 to center horizontal.

-2 to align on the right edge.

*YPos*

Position along y-axis.

-1 to center vertical.

-2 to align on the bottom edge.

*Mix*

Level of transparent color. (0-255) 0=invisible.

### Remarks

This command is used on BMP files already loaded, or loaded and showing, and allows the user to modify some of the parameters of a BMP display.

## Media Calls

### **mpgDir**

The *mpgDir* command returns the names of all files on the media player.

#### **Syntax**

```
mpgDir
```

### **mpgDelete**

The *mpgDelete* command permanently removes a media file from the media player.

#### **Syntax**

```
mpgDelete name
```

#### **Parameters**

*name*

The full name of the media file (video or graphic overlay) to remove. The list of all media can be obtained with the *mpgDir* command.

## Information Calls

### **infoGetFile**

The *infoGetFile* command returns the file playing on the specified channel.

#### **Syntax**

```
infoGetFile 0 channel
```

#### **Parameters**

*channel*

The channel on the media player (0-3)

## **infoGetPlaylist**

The *infoGetPlaylist* command returns the current playlist.

### **Syntax**

`infoGetPlaylist`

### **Parameters**

None

## **infoGetSchedule**

The *infoGetSchedule* command returns the current schedule or None if no schedule is in use.

### **Syntax**

```
infoGetSchedule
```

### **Parameters**

None

### **Returned Values**

Current schedule

None

If no schedule is in use.



## infoGetState

The *infoGetState* command returns the current playback state on the specified channel.

### Syntax

```
infoGetState 0 channel
```

### Parameters

*channel*

The channel on the media player (0-3)

### Return Values

STATE\_PLAY,  
STATE\_STOP,  
STATE\_PAUSE,  
STATE\_REW,  
STATE\_FF,

## Networking Commands

The following network commands are useful for network administration tasks.

### FireflySetDefault

The *FireflySetDefault* command resets the media player network settings back to *factory default state*:

- IP Address - 10.0.1.1
- Gateway - 0
- Netmask - 255.255.255.0
- Network Type - Static (2)
- Web Enable - On (0)
- Web User Name - firefly
- Web Password - 123456

### Syntax

```
fireflysetdefault
```

### Parameters

None

## **FireflySetIpAddr**

Use the *FireflySetIpAddr* command to change the IP Address of the media player.

### **Syntax**

*fireflysetipaddr IP Address*

### **Parameters**

*IP Address*

32 bit address used to identify a player on any network.

## FireflySetGateway

Use the *FireflySetGateway* command to change the network gateway of the media player.

### Syntax

```
fireflysetgateway gateway
```

### Parameters

#### *Gateway*

A service that allows media player to connect to other NetWare servers. Creating a gateway also allows client computers running only Microsoft client software to access NetWare resources through the gateway.

## **FireflySetNetmask**

The *FireflySetNetmask* changes the Netmask parameter for the media player.

### **Syntax**

```
fireflysetnetmask netmask
```

### **Parameters**

*Netmask*

Defines a subnet boundary range.

## FireflySetNetworkType

The *FireflySetNetworkType* command defines whether the media player, is on a Network using a DHCP server or simply set up Statically.

### Syntax

```
fireflysetnetworktype 1
```

### Parameters

*networktype*

1 = DHCP

(Dynamic Host Configuration Protocol) - A TCP/IP service protocol that offers dynamic leased configuration of host IP addresses and distributes other configuration parameters to eligible network clients.

2 = Static

For a local area connection (LAN), in IP address, Subnet mask, and Default gateway, type the IP address, subnet mask, and default gateway addresses.

## FireflySetWeb\_Enable

The *FireflySetWeb\_Enable* command offers the option to turn On or Off network communication to WebView.

### Syntax

```
fireflysetweb_enable 0
```

### Parameter

enable

0 = enable

1 = disable

## FireflyGetIpAddr

The *FireflyGetIpAddr* command retrieves current setting.

### Syntax

```
fireflygetIpAddr
```

## **FireflyGetGateway**

The *FireflyGetGateway* command retrieves current setting.

### **Syntax**

```
fireflysetgateway
```

## **FireflyGetNetmask**

The *FireflyGetNetmask* command retrieves current setting.

### **Syntax**

```
fireflygetnetmask
```



## FireflyGetNetworkType

The *FireflyGetNetworkType* command retrieves the current setting.

### Syntax

```
fireflygetnetworktype
```

## FireflyGetWeb\_Enable

The *FireflyGetWeb\_Enable* command retrieves the current setting.

### Syntax

```
fireflygetweb_enable 0
```

### Parameters

0 = enable

1 = disable

# LDV Control Commands

## Introduction

The Mantis may be controlled serially via the Laserdisc emulation control set described in this section. This interface sends commands to the Mantis dictating video playback, player settings or to report back system information.

- ❑ Commands received and recognized by the Mantis return a R (ACK)
- ❑ Commands not recognized report back to the controller as an error

The following sections describe setting up communication and programming the show controller.



Visual Circuit VCC control commands are proprietary and are not designed to be mixed with LDV control commands. Combining the two could cause inconsistent results and is not recommended.

## COM Port Settings

Any serial device can control the Mantis: manufacturers of these controllers include Crestron, AMX, Triad, Alcorn McBride and Sky Skan. This list of controllers is not all inclusive nor is it an endorsement of any one device.

Configure the controller communication port, COM port, to properly communicate data with the Mantis. These commands include either upper and/or lower case ASCII characters. Other ASCII arguments such as <CR> (carriage return) are also used.

The Mantis COM port is set up with the following factory default settings:

<b>Field</b>	<b>Setting</b>
Baud Rate	9600
Parity	None
Stop Bit	1
Data Bit	8

Other optional settings include:

<b>Field</b>	<b>Setting</b>
Baud Rate	Either 4800 or 1200
Parity	Odd or Even
Stop Bit	2
Data Bit	7

Be sure that the control device and the Mantis COM port settings are the same.



For Laserdisc Video serial communications, **LDV** must be selected in the *Command Mode* under *System Settings*. **VCC** is set for factory default.

## Command Language Basics

The Mantis receives and responds to the LDV command structure with the following addition: Channel Number. Because a single Mantis replaces the equivalent of 4 DVD or 4 Laserdisc players, the commands sent to the Mantis must be addressed to the corresponding output. This channel number leader is designated as:  $x @$  where  $x$  equals the desired channel or output. If no channel is designated, the Mantis interprets the command as a global command and all channels respond. When the Mantis receives a global command, it returns independent responses for each channel. Should a channel experience problems, the Mantis reports the specifics with an error code while the other healthy channels acknowledge command completion with <R>.

## Error Codes

The Mantis acknowledges a command by returning a <R>. When the Mantis receives an invalid command or address argument, it ignores the command and returns an error code. In the event that the command was global, each channel reports back independently. The following table describes the system error codes:

Code	Message	Meaning
NAK	Communication Error	Command or address argument cannot be parsed - invalid syntax.
E06	Missing Argument	Necessary parameter is not specified.
E11	Playlist not loaded	This error will occur any time a player control command is received while no playlist is loaded.
E12	Search Error	Search or stop marker address cannot be found.

## Command Syntax

- ❑ All commands shown in this section are in upper case
- ❑ There are no spaces in the command argument itself
- ❑ Between commands there are spaces

A sequence such as

```
<command1> ( space ) <command2> ( space ) <command3>  
( space ) <command4><CR>
```

indicates that four separate commands are to execute.

Some address arguments are required and some are optional.

- ❑ Whenever an address is required for a command, it is shown as <address>.
- ❑ Where an address is optional, it is shown as ( address ).

## Address Arguments

Some commands permit or require address arguments. These arguments can be used to specify a position (frame or timecode) address within a video or an address which identifies the position or sequence order of a video within a list of videos. A list of videos playing sequentially is a playlist.

Laserdisc refers to a video playlist as a Chapter or CH. To specify a file address within a chapter, the sequential position is indicated by *x*. CH5, for example, would indicate the fifth file in the playlist or chapter. Designating the file position *x* is also accepted. See *Chapter Number Request (?C)* on page 189 for command.

It is also possible to define an address within a video itself. *FRx* indicates a frame number within a video where *FR* denotes frame and *x* refers to the frame number. *FR3000*, for example, would refer to the frame 3000 of the current video. This equates to 100 seconds or 1 minute 40 seconds into the file. The frame number refers to actual video frames and calculating at 30 frames per second non drop, which is the NTSC standard, gives you the time elapsed at this frame of video. See *Frame Number Request (?F)* on page 187 for command.

*TMx* indicates a time code value using the format HHMMSSFF within the video.

H=Hour

M=Minute

S=Second

F=Frame

For example, *TM1263212* refers to the point at 1 hour, 26 minutes, 32 seconds and 12 frames in the video. The *TM* values will always be interpreted as a right justified value so *TM 3415* would reference the position 34 seconds and 15 frames into the video. See *Time Code Request (?T)* on page 188 for command.

## Command Summary

- ❑ All commands are either upper case or lower case characters as well as other ASCII characters
- ❑ Required address arguments are designated by <>
- ❑ Optional address arguments are designated by ()
- ❑ CH is the Laserdisc designation for playlist
- ❑ FRx is the Laserdisc designation for frame number within a video
- ❑ TMx is the Laserdisc designation for a specific timecode

## Playback Commands

### Play (PL)

Puts the designated channel(s) into play mode from the current file position and continues to play until the (address) value is reached. If no (address) is specified, play mode continues indefinitely.

### Syntax

( address ) PL<CR>

### Response

R<CR>

### Remarks

Use this command to begin playback on the selected channel(s) from the current file position.

- ❑ If an address value is included in the command, it defines the point at which playback automatically pauses. When the media player receives a PL command with an address, while playback is in progress, playback continues uninterrupted and the pause address is set as specified.
- ❑ If a PL command with no address is received during playback, playback continues uninterrupted and any previously set pause address is cleared.
- ❑ If a play command is received with an out of range address value, i.e. – time code greater than the length of the current file or a chapter number higher than the number of files in the playlist, the play command is not processed and the error code E12 is returned.

## **Examples**

3@TM13000PL<CR>

Play channel 3 from the current file position until the time code reaches 1 minute 30 seconds 0 frames and then pause.

1@CH5PL<CR>

Play channel 1 from the current file position until the head of chapter 5 is reached and then pause.

PL<CR>

Start all channels playing from their current file positions and continue playback until receiving another command. If a pause address had been set in any channel, clear that pause address.



## Load Playlist/Schedule (LD)

Loads a playlist/schedule.

### Syntax

“<filename>”LD<CR>



The LD command requires the use of quotes around the filename.

### Response

R<CR>

### Remarks

- ❑ This command is used to load a new playlist/schedule. When this command is received a check is done to be sure the specified filename actually exists on the media player hard drive. If it does not exist, then the error code E12 is returned and playback continues uninterrupted with the previous playlist/schedule.
- ❑ If the specified playlist/schedule is found on the hard disk, then playback of the previous playlist/schedule is halted and the new playlist/schedule is loaded.
- ❑ If “Auto Play” is enabled, playback will automatically start when a new playlist/schedule is loaded via the LD command. However, if “Auto Play” is disabled, playback will NOT automatically start; playback of the playlist/schedule must be started with the play (PL) command.

### Examples

“Tuesday.fpl”LD

Halts playback and loads the playlist named  
“Tuesday.fpl”.

“Summer1.fsc”LD

Halts playback and loads the schedule named  
“Summer1.fsc”

## **Reject “Stop” (RJ)**

Stops playback and resets the file pointer to the head of the playlist (equivalent to a stop button on a DVD or CD player).

### **Syntax**

RJ<CR>

### **Response**

R<CR>

### **Examples**

RJ<CR>

Stops playback on all four channels and resets playback pointers to head of playlist.

## Pause (PA)

Pauses the designated channel(s) at the current file position and blacks out the picture.

### Syntax

PA<CR>

### Response

R<CR>

### Remarks

The PA command will pause playback, Scan Reverse or Scan Forward. While having no visible effect on screen, it should also transition from Stop to Pause holding on frame 1 of the first file of the playlist. This is simply for compatibility with LDV devices which can use PA as a means of spinning up the disc without actually beginning playback. By transitioning from Stop to Pause the media player will give the control system the expected response if a status request is made later. In all cases, PA results in the target channel(s) being blacked out until another command is received. The Blackout will only remain in effect for as long as the channel(s) is in Pause mode. Any command which transitions the channel(s) out of Pause mode will also unmute the video on the specified channel(s)

### Examples

PA<CR>

Pauses all channels on the media player and blacks out the video outputs.

1@PA<CR>

Pauses channel 1 on the media player and blacks out the channel 1 video output.

## Still (ST)

Pauses the designated channel(s) at the current file position and freezes the picture.

### Syntax

ST<CR>

### Response

R<CR>

### Remarks

*ST* is treated exactly the same as *PA* except that instead of the video output going black, the current video frame is held on screen.

- ❑ If an *ST* command is received after a *PA* the effect will simply be to unmute the video output for the target channel(s).
- ❑ Likewise, if a *PA* is received after an *ST*, the effect is to mute the video on the target channel(s).

### Examples

ST<CR>

Pauses all channels on the media player and freezes the current frame on each video output.

1@ST<CR>

Pauses channel 1 on the media player and freezes the current frame on the channel 1 video output.

## Search (SE)

Jumps to the specified position within the current MPEG file or playlist.

### Syntax

<address>SE<CR>

### Response

R<CR>

### Remarks

- ❑ The Search command can jump to any I-frame within the current file or the head of any other file within the playlist.
- ❑ After executing the search command the specified channel(s) transitions to *Still Mode* until another command is received.
- ❑ In the event that a search command is received with an out of range address value (i.e. – chapter number higher than the number of files in the playlist) the search command is not processed and the error code E12 is returned.

### Examples

2@CH15SE

Jumps channel 2 to the head of the 15<sup>th</sup> file in the playlist and then transitions to still mode. If there are fewer than 15 files in the playlist for channel 2 error code E12 is returned and no change is made to the state of channel 2.

## Multi-Track Jump Forward (JF)

Jumps forward in the current MPEG file or playlist by the amount specified in the <address> argument.

### Syntax

<address>JF<CR>

### Response

R<CR>

### Remarks

- ❑ The *JF* command is similar to the search command except that the address argument is interpreted relative to the current file and playlist position and the new position is always forward of the current position.
- ❑ In the event that a *JF* command is received with an out of range address value (i.e. – chapter number greater than the remaining number of files in the playlist) the *JF* command will not be processed and the error code E12 will be returned.

### Examples

2@CH3JF

Jumps channel 2 to the head of the file 3 places down in the playlist and then transitions to still mode. If for example file 1 is currently playing on channel 2, this command would advance to the head of file 4. If there are fewer than 3 files remaining in the playlist for channel 2 error code E12 is returned and no change is made to the state of channel 2.

## Multi-Track Jump Reverse (JR)

Jumps backward in the current MPEG file or playlist by the amount specified in the <address> argument.

### Syntax

<address>JR<CR>

### Response

R<CR>

### Remarks

- ❑ The *JR* command is similar to the search command except that the address argument is interpreted relative to the current file and playlist position and the new position is always before the current position.
- ❑ In the event that a *JR* command is received with an out of range address value (i.e. – chapter number greater than the current file in the playlist) the *JR* command will not be processed and the error code E12 will be returned.

### Examples

2@CH1JR

Jumps channel 2 to the head of the current file and then transitions to still mode. The only condition under which this command could generate an error code would be if channel 2 was stopped or if no playlist was loaded.

2@CH3JR

Jumps channel 2 to the head of the second file before the currently playing file and then transitions to still mode. If for example file 4 is currently playing on channel 2, this command would advance to the head of file 2. If the currently playing file is less than the third file in the playlist error code E12 is returned and no change is made to the state of channel 2.

## Display Control (DS)

This command enables and disables the screen status and graphic overlay displays on specified channel(s) within the media player. The command enables one display and disables the other: only one display is enabled at a time.

### Syntax

xDS<CR>

### Response

R<CR>

### Remarks

This command is used to call up a graphic overlay onto a specified channel(s).

- ❑ 0 disables the channel status display and enables the graphic overlay display.
- ❑ 1 enables the channel status display and disables the graphic overlay display.
- ❑ Any other value is invalid and returns an error code of NAK without changing the state of the graphic overlay.

### Examples

0DS

Turns off the channel status display and turns on the graphic overlay for all channels of the media player. If the graphic overlay was already enabled on a channel at the time this command was received, no change is made to that channel.

2@1DS

Turns off the graphic overlay for channel 2 and turns on channel 2 status display. If the graphic overlay was already off for that channel no change is made.



## Frame Number Request (?F)

Requests the file position in the current MPEG file in frame number format.

### Syntax:

?F<CR>

### Response

<framenumber><CR>

### Remarks

- ❑ This command can be global or channel specific.
- ❑ If received as a global command, the media player responds with the file position for all 4 channels in order (1, 2, 3 and 4).
- ❑ If a channel is specified, only that channel's frame position is returned:

### Examples

Command	Response
1@?F <CR>	02045 <CR>
?F <CR>	01202 <CR> 00101 <CR> 08114 <CR> 10141 <CR>

## Time Code Request (?T)

Requests the file position in the current MPEG file in time code format.

### Syntax

?T<CR>

### Response

<timecode><CR>

### Remarks

- ❑ This command can be global or channel specific.
- ❑ If received as a global command, the media player responds with the file position for all 4 channels in order (1, 2, 3 and 4).
- ❑ If a channel is specified, only that channel's time code position is returned:

### Examples

Command	Response	Meaning
1@?T <CR>	0123329 <CR>	0Hr 12Min 33sec 29Fr
?T <CR>	0011402 <CR> 1081622 <CR> 0000612 <CR> 0103729 <CR>	0Hr 1Min 14Sec 2Fr 1Hr 8Min 16Sec 22Fr 0Hr 0Min 6Sec 12Fr 0Hr 10Min 37Sec 29Fr

## Chapter Number Request (?C)

Requests the position in the current playlist.

### Syntax

?C<CR>

### Response

<filenumber><CR>

### Remarks

- ❑ This command can be global or channel specific.
- ❑ If received as a global command, the media player will respond with the playlist position for all 4 channels in order (1, 2, 3 and 4).
- ❑ If a channel is specified, only that channel's playlist position is returned:

### Examples

Command	Response
1@?C <CR>	3 <CR>
?C <CR>	3 <CR> 1 <CR> 3 <CR> 7 <CR>

## Player Active Mode Request (?P)

Requests the current mode of the specified channel.

Note: The state after a reject command (*RJ*) will be P05 (stilled), not P01 (stopped).

### Syntax

?P<CR>

### Response

Response	
P01	indicates channel is stopped
P04	indicates channel is playing
P05	indicates channel is stilled (paused with image frozen)
P06	indicates channel is paused (paused with black screen)
P08	indicates channel is in fast forward or rewind

### Remarks

As with the other status request commands, this command can be global or channel specific. If received as a global command, the media player will respond with the mode for all 4 channels in order (1, 2, 3 and 4). If a channel is specified, only that channel's mode is returned:

### Examples

Command	Response	Meaning
1@?P <CR>	P04 <CR>	Playing
?P <CR>	P04 <CR> P01 <CR> P06 <CR> P05 <CR>	Channel 1 is Playing Channel 2 is Stopped Channel 3 is Paused Channel 4 is Stilled

## Mantis Model Request (?X)

Requests the number of available channels on the Mantis and the software version.

### Syntax

?X<CR>

### Response

<channels>V<softwarever><CR>

### Remarks

This command is always global and therefore should never include a target channel.

### Examples

Command	Response	Meaning
?X <CR>	4V2.00<CR>	4 channels ver 2.00 software
?X <CR>	2V3.12 <CR>	2 channels ver 3.12 software

## External Control Commands Quick Reference Guide:

### VCC Commands:

Playlistload  
Playlistplay  
mpgLoad  
mpgLoadDef  
mpgLoadNextDef  
mpgLoadNext  
mpgClearDef  
mpgPlay  
mpgStop  
mpgPlayAll  
mpgStopAll  
mpgSetInitOnOpen  
mpgBlack  
MantisFTPUpdate  
MantisSetDefault  
MantisSetIPAddr  
MantisSetGateway  
MantisSetNetmask  
MantisSetNetworkType  
MantisSetWeb\_Enable  
MantisGetIPAddr  
MantisGetGateway  
MantisGetNetmask  
MantisGetNetworkType  
MantisGetWeb\_Enable  
mpgCallback  
Play Complete Callback  
mpgSetVolumeLeftRight

osdLoadBMP  
osdShow  
osdHide  
osdSetXYMix  
genSetVideo  
genSetAudio 0 chip Source  
mpgDir  
infoGetFile  
infoGetPlaylist  
infoGetSchedule  
infoGetState

### LDV Commands:

Play (PL)  
Reject “Stop” (RJ)  
Pause (PA)  
Still (ST)  
Search (SE)  
Multi-Track Jump Forward (JF)  
Multi-Track Jump Reverse (JR)  
Display Control (DS)  
Frame Number Request (?F)  
Time Code Request (?T)  
Chapter Number Request (?C)  
Player Active Mode Request (?P)  
Mantis Model Request (?X)  
Load Playlist/Schedule (LD)

# TROUBLESHOOTING

---

## General Issues

### Restoration Mode

Restoration Mode allows the Mantis to self correct data corruption on its internal storage, thus restoring normal operation.

If a system fault occurs and player operations or video playback is erratic, try the following:

1. Restart the Mantis sometime before video playback normally occurs (approx. 30 sec.),
2. Press and hold the **Menu/Select** key on the front panel.
3. After the front panel display shows the message **Checking Content-Please Wait...** release the button.

It is normal for this process to take a few minutes because the system is checking the entire hard drive for errors.

If the system is still experiencing problems after completing the Restoration Mode procedure, review the following troubleshooting tips:

## **No Power to the Mantis (No LCD light or fan noise)**

When power is applied, the Mantis should automatically start up and begin playing back video.

If there is no LCD light, fan noise or CD/DVD drive function:

1. Confirm power outlets are live by plugging in another electrical device.
2. Verify that power cord is fully seated both at the outlet and to the Mantis player.
3. Verify that the Mantis power switch on the back of the system is in the on position.
4. Test power cable in alternate device or use different power cable.
5. If there is still no power, please contact your technical support representative.



## No Video Playback

On power up, the Mantis should automatically begin playing a video: either the Visual Circuits default or the last programmed. These videos are stored internally on the Mantis system hard drive. No CD or DVD is required.

If there is power to the Mantis, but no video playback, it is necessary to run the **Play Test File** routine. To access this test:

1. Go to the **General Settings** menu using the front panel controls and display.
2. Locate the **Play Test File** option.



### CAUTION

Care should be taken, whenever accessing the system settings so that no unintentionally changes are made. The accidental changing of some system settings can disturb or halt playback.



### Test File Will Not Play on Digital RF (ATSC) Channel

The Test File is for use on CVBS channels and will not run on the Digital RF.

3. To stop the test file playback, press any button on the front player. For further instructions, refer to *Front Panel* on page 10.
4. Wait to see if the Mantis player automatically initiates playback.
5. If the test file plays properly, but there is no playback when the test file playback is stopped, confirm that the video updating of the player was done successfully. For information about updating the Mantis, see *Updating Video Playback* on page 103.

## No Video Playback on Digital RF (ATSC) Channel

Verify that the file scheduled to play is a Transport Stream file, encoded at 19.39 Mbps.

## Test File Does Not Play Properly On All Channels

1. Inspect the video and audio cables.  
Each Mantis channel has both audio and video. Refer to *Plug and Play* on page 3 for information about MG video and audio connections.
2. Check the patch cable connections to ensure that they are firmly attached.  
Be sure to tie down cables for proper strain relief. Cables with no strain relief may disconnect or become damaged. Inspect the labels to ensure that the proper line out corresponds to the input device.
3. Confirm that the display works properly.  
Test with alternate video sources.

## Test File Does Not Display On One Channel

Switch the connection cable from a working channel to confirm the Mantis's output.

## Stuttering Files During Playback

Certain conditions can cause irregular playback on single and multiple channels:

1. **Programming that mixes video only MPEG files with MPEG with video and audio data.**

Confirm that all files on a particular channel are either video only, audio only, or audio/video files. It is recommended to encode a blank audio track with all MPEG files--even if there is no audio present on the source material. This ensures compatibility, should MPEGs with audio/video information be introduced at a later date.

2. **Use of Dolby Digital files**

Do not mix Dolby Digital files can with any other type of file on the same channel. All the file types on a particular channel must be the same.

3. **The bit rate of the MPEG files being played exceeds the system capabilities.**

Visual Circuits MPEG decoder boards and digital servers have a maximum sustained bit rates that they can delivered. Refer to *Encoding Requirements and Recommendations* on page 15 for more information. In addition, if there are other questions, consult a Visual Circuits representative prior to designing and encoding programming.

4. **Uneven audio to video track lengths.**

Confirm the length of the audio track to the length of the video track. The Visual Circuits driver aggressively synchronizes the audio and video data of the MPEG file to maintain Audio/Video (AV) Sync. If the MPEG file's audio and video tracks are uneven in length, the driver's attempt to synchronize these uneven tracks will result in poor performance.



**Mismatched A/V Track Lengths**

Mismatched AV track lengths result in an overall degradation of system performance. Often a bad file will cause uneven or stuttering playback on other channels of the system as well.

Through digital editing, MPEG 2 files can be de multiplexed, i.e. separating the audio from video information. The audio and video tracks can then be edited to match. The two tracks can then be multiplexed back together. Always test files individually if a file (or system) is suspected to have playback problems.

## Latent Images or Flashing During Playback

1. **Incorrect timecode or improperly closed encoding session.**

If the incorrect timecode is given for a particular file it is possible to encode a frame or two of the trailer or header information from the source. Often this extraneous frame is seen only briefly and can appear as a flash on the screen. Review the original source of the encoding and determine if the timecode are correct or if the encoding session was actually closed on the proper frame.

2. **Playing MPEG 1 and MPEG2 files back to back.**

The resolution switch from MPEG1 files (342X240) to MPEG2 files (720X480) causes a latent image or a quadrant display of the last played file's image. The only way to perform seamless playback when using a playlist is to insert an encoded black file with blank audio track, between MPEG1 and MPEG2 files. The black MPEG file preceding the playback file should be of the same standard. Thus to transition from MPEG1 to MPEG2 and back to MPEG1, the order of files is:

MPEG1

Black MPEG2 with a blank audio track

MPEG2

Black MPEG1 with a blank audio track

MPEG1

## Some files in the playlist do not play

All files on a playlist channel must be the same type.

If some are elementary stream, video only, and others are program stream, audio and video, some files are automatically skipped in order to keep playback running smoothly.

## SMPTE time codes are not recognized properly

Some SMPTE tracks lose information during compression and may not initiate events as required. It is recommended to encode these tracks hot, adding approximately +6 db to the track while encoding. Again, testing is essential to account for variances in encoders and SMPTE devices involved.



### **Eliminate Noise with Filter**

Simple audio filters, used at the installation site, are also useful in eliminating noise and cleaning up the SMPTE signal.

## File Related Problems

### File Copy Error Handling

There are three problems that can occur during file copying:

1. A file by the same name already exists on the internal storage.
2. Insufficient internal storage space.
3. An error occurs reading the data from the CD/DVD.

### Filename Already Exists

This is a non-fatal error and the system provides an opportunity rename file and proceed.

### Insufficient Disk Space

When a copy routine begins, the system checks to see that there is sufficient internal storage available to write the files to disk and have an additional safety margin of 300MB. If this condition is met the copy continues. If there is not enough internal storage available the system issues a warning message to that effect.

### CD/DVD Update Disc Fails

Insert the update disc(s) into the Mantis CD/DVD drive. The update occur automatically and the LCD displays the update activity. When the update is complete, the Mantis automatically ejects the disc.



#### **Do Not Eject Disc During Update Process**

Opening the drive bay while the update is in progress interrupts the Mantis automatic update process.

## Serial Command Fails, Returning NAK

If a serial command that contains a filename fails, check the filename. Files handled by serial commands can not have spaces in them.



### Filename Conventions

The Mantis provides three interfaces, that allow the creation and naming, or transferring of files: front panel controls, WebView, and External Control Commands. To insure compatibility between them, filenames must conform to the following conventions:

- up to 214 alphanumeric characters (capitals and lowercase) in length
- can include spaces dashes, and underscores
- can begin with either alpha or numerical character

## Update Fails

1. Inspect the update discs for scratches and smudges. Use another set of update discs if necessary.
2. Record any information displayed on the front panel display and then contact Visual Circuits Technical Support.

## Smart Card does not eject

If the green indicator light to the left of the Smart Card reader slot is lit, the card should eject the card using WebView or the front panel controls, see *Eject the Smart Card* on page 27 for details.

If the green indicator light to the left of the Smart Card reader slot is NOT lit and there is a card in the slot, this likely means either that:

- The Visual Circuits Smart Card is inserted incorrectly.
- The card in the slot is not a Visual Circuits Smart Card.

To force an ejection of the contents from the card reader, press and hold the **EXIT** button on the front panel for 7 seconds. After that time, the system should eject the card.



### Do Not Force Eject During Start Up Process

Instead, during the startup process, press and release the **Exit** button on the Mantis front panel to eject the Smart Card.



## Preventing Cabling and Connection Problems

The tips below are to prevent problems related to Mantis cabling and connections.

- ❑ Use high quality cable.
- ❑ Keep cable lengths as short as possible.  
For composite video, PAL or NTSC, RG-59 the maximum cable distance is 20 meters between the video source and the acceptor. No signal deterioration should show on the screen. For longer distances, up to 30 meters, use RG-11 type cable. For s-video, standard, inexpensive cables allow operating distances of 5-7 meters. Very little deterioration is apparent. For component video, RG-59 cables are suitable for up to 10 meters. For longer distances, up to 20-25 meters, a better cable should be used, such as RG-11.
- ❑ Check that impedance of the cable actually matches the application. The Mantis is terminated at 75 ohm.
- ❑ Check the connectors on the cables. Poor quality connectors may have worse effects than the cables themselves.
- ❑ Use appropriate amplifiers if needed.
- ❑ Keep cables away from sources of interference such as electric motors, main cables, transmitters, and light dimmers.

# Front Panel Display Error Messages

## Bad FPL/FSC

The syntax of the playlist (.fpl) or schedule (.fsc) loaded is incorrect. Review the playlist/schedule with the Mantis Media Messenger to verify syntax.

## Bad FTP Dir

The FTP directory was not found. Verify with network administrator for FTP directory. Also verify the FTP directory on the front panel display menu.

## Bad IP Address

The FTP server at this address could not be located. Verify the IP address and proxy settings with the network administrator.

## Bad User/Pass

The FTP user name and password were not accepted by the FTP server. Review FTP account information for the user to make sure name and password are correct.

## Cant List Media

The FTP server permissions are not set correctly. On the FTP server, enable List permissions on the media directory.

## Cant List Scripts

The FTP server permissions are not set correctly. On the FTP server, enable List permissions on the scripts directory.

## Download Fail

An error occurred from downloading media from the FTP server. The media may have been corrupted. Verify the integrity of the media by using another PC or system.

## FTP Failed Networking Off

The network mode is set to **No Network**. The network settings need to be setup. See *Mode* on page 78 or contact the network administrator for assistance on setting up networking.

## Invalid FTP IP

The FTP IP address is in the incorrect format. Correct the IP address found in the FTP Auto-Update Settings screen, see *FTP Auto-Update Settings* on page 87.

## Missing MPEG/Overlay

During CD/DVD or FTP updating, an MPEG video or graphic overlay in the playlist was not included. Verify media on the CD/DVD or via FTP by using another PC or system.

## No Directory

The scripts sub-directory was not found on the FTP server. Verify with the network administrator the existence of the scripts folder.

## No IP Address

The FTP IP address was not specified. To correct, insert an IP address in the appropriate menu, see *FTP Auto-Update Settings* on page 87.

## No Local FPL/FSC

The format of the currently selected playlist/schedule is invalid. Create a new active playlist/schedule. Refer to the Media Messenger User Manual for details.

## No Valid TAR/FPL

There is nothing in the scripts directory that applies to this player. Create a new TAR/FPL and post it on the server, following the naming and updating requirements found in *FTP Updating* on page 113.

## Proxy Settings

The IP address of the proxy server is invalid. Correct the proxy server IP address. Refer to *Network Settings* on page 78.

## Transfer Error

An error occurred while downloading media from the FTP server. Verify patch cable and connection port to network and retry. If FTP update fails again, consult with the network administrator to verify the connection.

## Returning Materials to Focus Enhancements (VAR/Distributor)

If the Mantis system has problems that cannot be corrected over the telephone by Focus Enhancements technical support, it may be necessary to return the Mantis to Focus Enhancements Midwest Headquarters.

All materials shipped back to Focus Enhancements must be accompanied by a Return Materials Authorization (RMA) number. Contact Focus Enhancements Technical Support to receive a RMA number.

Write the RMA number clearly on the shipping label.



**Figure 1.** RMA Shipping Label



**Do Not Return Smart Card with Mantis**

In the event the Mantis needs to be returned for service, Do Not send its Smart Card back with it. Instead, keep the Smart Card in a secure location to avoid loss or damage



# TECHNICAL SPECIFICATIONS

---

<b>Features</b>	<b>Description</b>
<b>Basic System</b>	Visual Circuits Gemini 2 Universal Media Card SmartCard 160GB HDD storage CD/DVD drive Gemini (per channel) NTSC, PAL Decodes all 18 ATSC formats up to 1920x1080p 16:9, 4:3, 5:4 aspect ratios High-quality up and down scaling CVBS, S-video, Component (PbPrY), or HV per channel 32-bit OSD; 256-level transparency 32-bit high-resolution accelerated graphics
<b>Networking</b>	10/100 Mbps Ethernet Integrated KenCast FAZZT™ client (option) FTP, HTTP auto-updating
<b>Serial and Ethernet Control</b>	AMX, Leightonix, Crestron, Contemporary Research certified; Visual Circuits and LDP protocol libraries
<b>Audio</b>	Stereo or Dolby Digital™ via S/PDIF; stereo analog MPEG Layers 1, 2, 3
<b>Video</b>	MPEG-1 ISO 11172 MPEG-2 ISO/13818-2 Program, transport and elementary streams NTSC/PAL transcoding Constant or variable bit rate decoding 45 Mbps maximum bit rate (includes text)
<b>Software</b>	WebView — HTML-based setup, monitor and control interface. Requires Internet Explorer 5.5 or higher  Media Messenger — for managing and distributing media via FTP or HTTP to a single Mantis MG server  Media Messenger Multi-player version (optional) — for managing and distributing media via FTP, HTTP or multicast to groups of networked Mantis, Firefly or POPVideo servers
<b>Physical MG</b>	13.34 cm (5.25") high (3RU) x 43 cm (17") wide x 43.82 cm (17.25") deep.
<b>Weight MG</b>	Approximately 6.8 kg (15 lbs.)
<b>Power</b>	100-240VAC, 50/60Hz, Approx 60 Watts

<b>Features</b>	<b>Description</b>
<b>Temperature Range</b>	0° - 40° Celsius continuous operation (0° - 65° C short-term)
<b>Certification / Regulation</b>	FCC - Part 15, Class A; CE



## Numerics

- 24-bit format 38, 45, 110
- 75 ohm 203

## A

### a/v

- last sync 66
- sync 66, 97

### AC3 19

add video to playlist 43

additional channels

- smart card 23

address argument

- LDV 175

advanced settings 97

- audio/video sync 97
- merge playlists 97
- reset stats 98

all channels

- playback
- resume 143
- playback, start 143
- playback, stop 144

all installed cards

- playback, resume 143
- playback, start 143
- playback, stop 144

argument, missing 174

ASCII generating control prog 131

ATSC

- troubleshooting 196

audio

- bit rate 64
- bit rate, SD 16
- cabling 203
- connection 6
- digital 6

Dolby Digital 15, 197

filter out noise 200

frequency 64

line-level 3

off 152

on 153

output impedance 19

output level 19

output termination 6

playback data 66

S/PDIF 6, 75

sampling rate 19

stream 17

test tones 17

audio level, base line 17

audio settings

- channels 75

- volume 75

audio/video sync 198

audio-video

- see a/v 66

auth passphrase 82

auto key 47

auto play 77

automatic updating 109

AV

- see a/v 66

## B

background

- removing 47

- residual color 47

basic system configuration 2

baud rate 77

bit rate 16, 20, 197

- audio, SD encoding 16

- sampling, SD encoding 16

- video 64
- bitmap
  - 16-color 154
  - 256-color 154
  - load 154
- black file 199
- black MPEG 199
- blocking 46
- BMP 20, 158
  - display 156
  - hide 157
- C**
- cabling 203
  - component video 203
  - composite 203
  - impedance 203
  - NTSC 203
  - PAL 203
  - RG-11 203
  - RG-59 203
  - termination, 75 ohm 203
- callback commands 150
- calls
  - information 160
- CD/DVD
  - date/time, last update 63
  - missing graphic overlay 205
  - missing MPEG 205
  - updating 110
  - updating fails 201
- channel
  - empty 44
  - no video playback 195
  - numbers 4
  - playback, interrupt 136
  - playback, start 141
  - playback, start next 137
  - stuttering video 197
- CHx, LDV playback 175
- cleanup routine 107
- client
  - multicast 94
  - USB devices 90
- client enable 94, 119
- code, security 98
- color bars 17
- command, control
  - audio 151
  - callback 150
  - Firefly system 149
  - information calls 160
  - LDV 172
  - media calls 159
  - networking 164
  - on-screen display 154
  - video 151
- commands 134
  - FireflyFtpUpdate 149
  - FireflyGetGateway 170
  - FireflyGetNetworkType 171
  - FireflyGetWeb\_Enable 171
  - FireflyRestart 149
  - FireflySetDefault 164
  - FireflySetGateway 166
  - FireflySetIpAddr 165
  - FireflySetNetmask 167
  - FireflySetWeb\_Enable 169
  - infoGetFile 160
  - infoGetPlaylist 161
  - infoGetSchedule 162
  - infoGetState 163
  - mpgBlack 145
  - mpgClearDef 140
  - mpgDelete 159
  - mpgDir 159
  - mpgLoad 136
  - mpgLoadDef 138
  - mpgLoadNext 137
  - mpgLoadNextDef 139

- 
- mpgPlay 141
  - mpgPlayAll 143
  - mpgSetVolumeLeftRight 151
  - mpgStop 142
  - mpgStopAll 144
  - mpgUnblack 146
  - osdHide 157
  - osdLoadBMP 154
  - osdSetXYMix 158
  - osdShow 156
  - playlist 134
  - playlistload 134
  - playlistplay 135
  - commands, LDV
    - ?C (chapter number request) 189
    - ?F (frame number request) 187
    - ?P (player active mode request) 190
    - ?T (time code request) 188
    - ?X (Mantis model request) 191
  - display control (DS) 186
  - JF (multi-track jump forward) 184
  - JR (multi-track jump reverse) 185
  - LD (load playlist/schedule) 179
  - PA (pause) 181
  - PL (play) 177
  - RJ (reject or stop) 180
  - SE (search) 183
  - Still (ST) 182
  - communication error 174
  - component 74
  - component video 203
  - composite 74, 203
  - configuration
    - video card 74
  - configuration settings
    - save 25
  - connecting
    - audio cables 203
    - video cables 203
  - connections
    - audio 6
    - video 5
  - content log 108
  - content missing
    - playlist 83
  - content missing, update 83
  - content update processing 105
  - control setting
    - parity 77
  - control settings
    - accept TCP/IP 76
    - accept UDP 76
    - auto play 77
    - baud rate 77
    - data bits 77
    - serial echo 77
  - control, VCC 134
  - convert to 24-bit format 38, 45, 110
  - create playlist using serial commands 147
  - creating a FTP update account 114
  - creating a new schedule 51
  - creating new playlist 43
  - cropping 46
  - current video frame 65
- D**
- data
    - audio, on chip 66
    - raw, on chip 67
    - underflow 67
    - video, on chip 66
  - data bits 77
-

- date rules
  - adding 55
  - editing 60
- date/time 71
- de multiplex 198
- delete file 159
- delete video from playlist 43
- DHCP 33, 78, 168
- diagnostic
  - audio bit rate
  - audio 64
  - general, hardware version 63
  - general, last CD/DVD update 63
  - general, last FTP update 63
  - general, layer version 63
  - general, loaded playlist 63
  - general, loaded schedule 63
  - general, software version 63
  - general, system starts 63
  - general, video loaded by
    - channel 63
  - general, watchdog restarts 63
  - playback audio data 66
  - playback channel 66
  - playback interrupts 66
  - playback video data 66
  - playback, a/v sync 66
  - playback, last a/v sync 66
  - video, audio frequency 64
  - video, bit rate 64
  - video, channel monitored 64
  - video, current frame 65
  - video, file type 65
  - video, frame rate 65
  - video, image size (H) 64
  - video, image size (V) 64
  - video, time code 65
- diagnostic log 69, 84
  - DVD updating 127
  - error summary 127
  - error summary log 69
  - FTP updating 127
  - FTP/DVD updating data 69
  - logfile viewer 70
  - missing elements log 69
  - missing media 127
  - serial commands 69
  - storage cleanup 127
  - storage cleanup data 69
- diagnostic logs 127
- Diagnostics
  - logging 68
- diagnostics 62
  - general 63
  - logging 68
  - playback 66
  - video 64
- dialup connect
  - FTP auto-update 88
  - network 80
- dialup retries
  - FTP auto-update 88
  - NTP 80
- digital audio 6
- digital RF
  - no playback 196
  - test file will not play 195
- direct file access updating 122
- directories 87
- directory
  - HTTP auto-update 89
- disk underflow 67
- display BMP 156
- DNS 33
- Dolby Digital 15, 19, 197
- download
  - logs 130
- download, fail 205
- Drop & Go 111

- 
- creating 111
    - using 112
  - DTD 128
  - DVD
    - diagnostic log 127
    - updating data 69
  - DVMPEG 18
  - dynamic IP address 33
  - E**
  - E06 174
  - E11 174
  - E12 174, 177, 183, 184, 185
  - eject 96
  - eject smart card 96
  - elementary stream 15, 200
  - eliminate noise 200
  - empty channel 44
  - empty rows
    - playlist editor 50
  - encoding 10, 15, 20
    - bit rate 16, 197
    - Dolby Digital 15
    - elementary stream 15
    - HD 19
    - hot tracks 200
    - imporper closing of session 199
    - NTSC resolutions 16
    - output, total 15
    - PAL resolutions 16
    - program stream 15
    - PTS values 15
    - recommendations 10, 15
    - recommendations, SD 16
    - requirements 10, 15
    - requirements, SD 15
    - SMPTE 17
  - encoding software
    - Pixel Tools 20
  - Video Clippro 21
  - end code 16
  - error summary
    - diagnostic log 127
    - error summary log 69
  - errors
    - communication 174
    - data underflow 67
    - disk underflow 67
    - E06 174
    - E11 174
    - E12 174, 177, 183, 184, 185
    - external control cmnds 174
    - media copying 201
    - missing argument 174
    - NAK 174
    - read 67
    - search 174
  - event
    - adding 52
    - days of week 51
    - deleting 56
    - interrupt 51
    - interval 51
    - play once 51
    - playlist name 51
    - properties 51
  - events
    - start time 51
    - stop time 51
  - expansion card slots 4
  - external control commands 131
    - LDV error codes 174
    - quick reference guide 192
  - F**
  - fade in rate 47
  - fade out rate 47
  - fade rate 47
  - fan off 194
-

- Fazzt 117
- file
  - access 86
  - access, enabling 122
  - conversion 38, 45, 110
  - formats 38, 65
  - open MPEG file 136
  - playback, stop 142, 144
  - queue 139
  - reload 142, 144
  - remove 159
  - return name 159, 160
- file playback
  - message, mpg\_file\_read\_start 137
- file, creation date 108
- filename
  - .fpl 105
  - .fsc 105
  - .tar 105
  - firefly 105
  - siteid 105
- Firefly
  - overview 1, 99, 193
- fixed update interval 88, 89
- flashing 199
- frame number, LDV 176, 187
- frame rate 65
- frequency response 19
- front panel
  - loading settings from smart card 26
  - security code 98
- front panel display 10
  - date/time 13
  - error messages 204
  - menu 12
  - system settings 11
  - video output 12
- FTP
  - auto-update settings 94
  - client 123
  - date/time last update 63
  - diagnostic log 127
  - directory 87
  - directory error 204
  - download fails 205
  - invalid IP address 205
  - last connect 63
  - list error 204
  - networking off 205
  - no IP address 205
  - password 204
  - port 122
  - proxy address 79
  - proxy port 79
  - proxy type 79
  - script error 204
  - server 113
  - software 113
  - transfer error 206
  - update account 114
  - update process 115
  - updating 113
  - updating data 69
  - updating order 115
  - upload logs 129
  - username 204
- FTP auto-update
  - delete content 88
  - dialup connect 88
  - dialup retries 88
  - directory 87
  - fixed update interval 88, 89
  - FTP update now 88
  - IP address 87
  - password 87
  - port 87
  - site ID 71
  - update interval 87

---

username 87

**G**

gateway 79, 166  
    current settings, return 170  
general settings  
    date/time 71  
    software version 72  
    system uptime 72  
    time zone 72  
GOP (Group of Pictures) 16  
graphic file formats 38  
graphic file transfer and  
conversion 38  
graphic overlay 42  
    adding 44  
    background 47  
    empty channel 44  
    fade in rate 47  
    fade out rate 47  
    key color 46  
    positioning 47  
    properties 46  
    serial commands 154  
    transparency level 46  
    working with 45

**H**

hardware  
    version 63  
hardware encoding service 21  
HD, see high definition 19  
high definition  
    encoding 19  
high definition recommendations  
20  
host name 78  
HTTP  
    address 89

directory 89  
port 89  
proxy address 80  
proxy port 80  
proxy type 80

hwnd 150  
hyper terminal 133

**I**

ICMP 94  
image  
    flashing 199  
    latent 199  
    size, horizontal 64  
    size, vertical 64  
impedance 203  
information calls 160  
insufficient free space 201  
interrupt  
    playback 66  
IP address 79  
    change 165  
    dynamic 33, 168  
    FTP auto-update 87  
    HTTP auto-update 89  
    static 32, 168  
    troubleshooting 204

**K**

KenCast 94, 117  
    package mode 118  
    script last mode 118  
key color 46  
    background 47  
key out 46

**L**

Laserdisc

- see LDV 172
  - latent image 199
  - LCD off 194
  - LDV
    - address argument 175
    - command syntax 175
    - control commands 172
    - error codes 174
    - frame number (FRx) 176
    - playback commands 177
    - settings, COM port 172
    - time code (TMx) 176
    - video playlist (CHx) 175
  - Linux, modified time 108
  - listen address 95, 119
  - listen port 95, 119
  - load
    - file 136, 137, 138
    - GIF 158
    - playlist 134
  - load a bitmap 154
  - load config 96
  - loading locally 59
  - local load 59
  - local save 58
  - log
    - error summary 69
    - format 85
    - missing elements 69
  - serial commands 69
  - log default playlist 128
  - log files 125
    - content log 108
    - diagnostic logs 84, 127
    - log default playlist 85
    - log format 85
    - max log MBs 85
    - run logs 84, 126
    - upload 108
    - upload logs 85
  - uploading 129
    - WebView 68
  - log format 128
  - log, content 108
  - logging
    - default playlist 85
    - diagnostic log 84
    - diagnostic logs 69, 127
    - download to PC 130
    - log default playlist 85, 128
    - log format 85
    - max log MBs 85, 129
    - run logs 67, 126
    - settings 128
    - upload logs 85
    - upload logs to server 129
    - WebView 68
  - looping playlist 139
- M**
- Mantis
    - output, total 15
  - manual updating 121
  - masking 46
  - max log MBs 85, 129
  - media
    - copying errors 201
    - deleting 39, 41
    - previewing 39
    - reviewing 39, 40
    - transferring 36
    - updating 109
  - Media Messenger 1, 101, 109
  - Media Update Discs
    - using 110
  - media update discs
    - creating 109
    - features 109
  - menu
    - control buttons, front panel 10



- 
- menu control buttons 10
  - menu, front panel display 12
  - merge playlists 97
  - message
    - file playback,
      - mpg\_file\_read\_start 137
  - Microsoft bitmap 154
  - Microsoft client software 166
  - missing argument 174
  - missing elements 127
  - missing elements log 69
  - missing graphic overaly 205
  - missing media 127
  - missing MPEG 205
  - mode 78
  - modified time 108
  - monitor
    - component 6
    - composite 6
  - MPEG 17, 197
    - black file 199
    - open file 136
    - seemless transistion MPEG1 to MPEG2 199
  - MPEG1 19
    - latent image 199
    - system stream 15
  - MPEG2 19
    - elementary stream 15
    - latent image 199
    - layer 2 15
    - program stream 15
    - transport stream 15
  - mpgCallback 150
  - mpgPlayall 135
  - mpgSetVolumeLeftRight 152, 153
  - mtime 108
  - multicast
    - client 94
    - client enable 94, 119
    - delete channel 95
    - Fazzt 117
    - ICMP 94
    - KenCast 94, 117
    - listen address 95, 119
    - listen port 95
    - package mode 118
    - port address 119
    - reserve MBs 95, 120
    - script last mode 118
    - smart card 23
    - transfer order 95, 119
    - update content missing 83
    - updating 117
  - multiplexing 198
  - multi-stream applications 20
- N**
- NAK 174
  - netmask 79, 167
  - netmask SNMP 81
  - NetWare servers 166
  - network
    - change gateway 166
    - gateway 79
    - host name 78
    - IP address 79
    - mode 78
    - netmask 79
    - NTP dialup retries 80
    - NTP server 80
    - NTP sync interval 80
    - NTP, enable 80
    - proxy address 79
    - proxy type 79
    - reset settings 164
    - SNMP 81
    - SNMP auth passphrase 82
    - SNMP netmask 81
    - SNMP password 82
-

- SNMP security name 81
  - static IP 78
- Network Time Protocol
  - see NTP 80
- network type
  - current settings, return 171
- Networking 99
- networking commands 164
- new playlist 43
- no power 194
- NTP
  - enable 80
  - server 80
  - sync interval 80
- NTSC 38, 45, 73, 110, 203
  - cropped 74
  - resolution 16

## O

- on-screen display commands 154

## P

- package mode 118
- PAL 203
  - cropped 74
  - resolution 16
- parity
  - control settings 77
- parsing routine 106, 116
- password 34, 204
  - FTP auto-update 87
  - WebView 86
- pause 61
- PCM, analog output 75
- Pixel Tools 20
- play 61
  - playlist 135
- play a file 141, 143
- play button 49

## playback

- a/v sync 66
- all channels 143
- all channels, resume 143
- all channels, start 143
- all channels, stop 144
- all installed cards, stop 144
- audio data 66
- files skipped in playlist 200
- flashing 199
- interrupts 66
- latent image 199
- no video 195
- return state 163
- seamless MPEG1 to MPEG2
  - 199
- start 141
- stop 142
- stop, all channels 144
- video data 66

## player

- management 114
- version 63

## Player Control Panel 61

- playlist 3, 42
  - adding graphic overlay 44
  - adding video 43
  - clear 140
  - content missing 83
  - create with serial commands
    - 147
  - creating 43
  - currently loaded 63
  - events editor 50
  - files skipped during playback
    - 200
  - graphic overlay 45
  - looping 139
  - moving video 44
  - new 43

---

- parsing routine 106, 116
- playing 49
- removing video 43
- return 161
- saving 48
- shuffle video 44
- playlist editor 42
  - WebView 42
- Playlistload 135
- playlists
  - playlist not loaded 174
- plug and play 3
- port
  - 2180 76
  - FTP auto-update 87
  - HTTP 89
- port 2180 132
- positioning 47
- presentation time stamp 15
- previewing media 39
- priv passphrase 82
- program stream 15, 200
  - end code 16
- properties of graphic overlays 46
- proxy
  - address, FTP 79
  - address, HTTP 80
  - port, FTP 79
  - port, HTTP 80
  - server, troubleshooting 206
  - setting, troubleshooting 204
  - type, FTP 79
  - type, HTTP 80
- proxy address 206
- proxy settings
  - IP address invalid 206
- PTS 15

**Q**

- quadrant display 199

- queue file to play 139

## R

- rate
  - audio bit rate 64
  - frame 65
  - video bit rate 64
- read errors 67
- recommendations
  - encoding, HD 20
  - encoding, SD 16
- reload a file 142, 144
- remove video from playlist 43
- reserve MBs 95, 120
- reset network settings 164
- reset stats 98
- resolution 16
- restoration mode 193
- return
  - state, playback 163
- return materials authorization 207
- RG-11 203
- RG-59 203
- RGB 4, 47, 74
- RMA 207
- RS232 76, 131
- run logs 67, 84, 126

## S

- S/PDIF 6, 75
- sampling bit rate
  - SD encoding, recommended 16
- saving
  - locally 58
  - playlist 48
  - smart card config 96
- schedule 50
  - adding event 52

- creating 51
- currently loaded 63
- deleting event 56
- new 51
- return 162
- saving 57
- schedule editor 50
  - exiting 60
- script last mode 118
- scripts subdirectory 205
- search error 174
- security access code 98
- security name 81
- serial commands
  - create playlist 147
  - record 69
- serial echo 77
- server
  - NTP 80
- service
  - hardware encoding 21
- setting date/time 71
- show control system 131
- shuffle video 44
- site ID 71, 113
- smart card 96
  - ejecting 27
  - failure to eject 202
  - inserting 24
  - load config 96
  - loading 26
  - loading configuration 23
  - optional Mantis features 23
  - save config 96
  - saving configuration 23
  - saving settings using the front panel 25
  - settings, configuration, saving 25
  - using the front panel to load settings 26
  - using WebView to load settings 26
  - using WebView to save settings 25
- SMPTE 17
  - time codes not recognized 200
- SNMP
  - auth passphrase 82
  - community 81, 83
  - enable 81
  - engine ID 81, 83
  - netmask 81
  - network 81
  - playlist content missing 83
  - priv passphrase 82
  - security name 81
  - trap server 82
  - update content missing 83
  - version 83
  - watchdog 83
- software
  - FTP 113
  - update 38
  - version 63, 72
- specifications
  - technical 209
- standard CD/DVD updating 121
- standard definition encoding recommendations 16
- standard definition encoding requirements 15
- start playback 141
- static IP 78
- statistics
  - reset 98
- stop 61
- stop playback 142, 144
- storage cleanup 127
- storage cleanup data 69

- 
- subnet boundary range, define 167
  - s-video 74
    - cabling
      - s-video 203
  - sync
    - a/v 66
    - a/v, last 66
  - sync interval
    - NTP 80
  - syntax
    - LDV command 175
  - system
    - basic 2
    - restart 149
  - System Settings
    - FTP auto-update settings 94
  - system settings 71
    - advanced settings 97
    - audio 75
    - control 76
    - date/time, front panel display 13
    - front panel display 11
    - FTP auto-update 87
    - general 71
    - HTTP 89
    - loading with Smart Card 23
    - multicast 94
    - network 78
    - save 25
    - saving with smart card 23
    - smart card 96
    - USB devices 90
    - video 73
    - video output, front panel display 12
    - WebView 86
  - system software updating 113
  - system starts 63
  - system stream
    - MPEG1 15
  - system update check
    - updating
      - system 108, 116
  - system uptime 72
- T**
- tar files 109
  - TCP/IP 78, 113, 132, 168
    - control settings 76
    - netmask 79
  - technical specifications 209
  - termination
    - audio 6
    - video 6
  - test file
    - does not play 196
    - video 195
  - TGA 20
  - TIFF 20
  - time code 65, 199
  - time code, LDV 176, 188
  - time zone 72
  - transcode 17
  - transfer error 206
  - transfer order 95, 119
  - transition, seamless 137
  - transparency level 46
  - transport stream 19, 196
    - MPEG2 15
  - Troubleshooting 193
  - troubleshooting
    - ASTC 196
    - no power to mantis 194
    - proxy settings 204, 206
    - restoration mode 193
- U**
- UDP
-

- control settings 76
- underflow
  - data 67
  - disk 67
- upd files 108
- update
  - date/time, last FTP 63
  - fail 202
  - last CD/DVD 63
  - software, WebView 38
- update interval 87
- update packet 105, 109
- updating
  - automatic 109
  - data, DVD 69
  - data, FTP 69
  - direct file access 122
  - Drop & Go 111
  - FTP 113
  - manual 121
  - media 109
  - multicast 117
  - routine order 106
  - standard CD/DVD 121
  - system software 113
  - video playback 103
  - WebView 121
- uploading log files 85, 129
- USB
  - dialup client 90
  - server 93
- user manual
  - WebView 35
- username 34, 86, 204

## **V**

- VCC control commands 134
- version
  - hardware 63
  - software 63, 72

- video
  - bit rate 64
  - cabling 203
  - connections 5
  - content, update 149
  - cover 145
  - dates 54
  - flashing 199
  - mode 3
  - moving on playlist 44
  - no playback 195
  - NTSC cropped 74
  - output termination 6
  - output type, configuration 4
  - PAL cropped 74
  - play test file 195
  - playback data 66
  - resolution 16
  - shuffle 44
  - standard 3
  - stream 17
  - stuttering 197
  - supported standards 74
  - uncover 146
- video card configuration 74
- Video Clippro 21
- video dates editor 50, 54
- video output type 74
  - RGB 4
- video settings
  - supported standards 74
  - video card 74
  - video output type 74
  - video standard 73
- video standard 73
- videoname 136, 137, 138, 139
- volume 75
  - set left 151
  - set right 151

**W**

- Watchdog 63, 98
- web browser 29
- WebView 1, 29
  - deleting media 39
  - diagnostics 62
  - enable 169
  - file access 86
  - loading settings from smart card 26
  - log files 68
  - logging 68
  - password 34
  - Player Control Panel 61
  - playlist editor 42
  - previewing media 39
  - reviewing media 39
  - schedule editor 50
  - settings 86
  - setup procedures 31
  - system settings 71
  - system settings, save to smart card 25
  - transferring media 36
  - user manual 35
  - username 34
  - video dates editor 54
- WebView Settings
  - username 86
- WebView settings
  - password 86







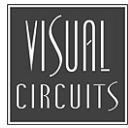

813-0053b

© 2005 Focus Enhancements